

# TELEPHONES



TELEPHONE PARTS  
AND SUBSTATION ACCESSORIES

## INDEX

C.B. Monophones	7-17
C.B. Telephones, Misc.	18-23
L.B. Monophones	24-26
L.B. Telephones, Misc.	27-28
Binger Boxes	29-31
Signals, Miscellaneous	31-32
Telephone Parts	33-39
Accessories and Tools	40-44
Piece Parts	45-57
Complete Index	58-60

**AUTOMATIC**  **ELECTRIC**

MAKERS OF TELEPHONE AND SIGNALING APPARATUS  
ELECTRICAL ENGINEERS, DESIGNERS AND CONSULTANTS  
1033 WEST VAN BUREN STREET, CHICAGO, U. S. A.

**CATALOG 4055-C**

June 1940

# TELEPHONES TELEPHONE PARTS and SUBSTATION ACCESSORIES

CATALOG 4055-C

AMERICAN AUTOMATIC ELECTRIC SALES COMPANY  
641 EAST GAGE AVENUE  
LOS ANGELES, CALIFORNIA

**AMERICAN AUTOMATIC ELECTRIC SALES COMPANY**

1033 West Van Buren Street, Chicago, U. S. A.

*Distributor for Products of* **AUTOMATIC ELECTRIC COMPANY** *and other Companies*

---

EXPORT DISTRIBUTORS: AUTOMATIC ELECTRIC SALES COMPANY, LIMITED

# AUTOMATIC ELECTRIC

MAKERS OF TELEPHONE, SIGNALING AND COMMUNICATION APPARATUS  
ELECTRICAL ENGINEERS, DESIGNERS AND CONSULTANTS

## DISTRIBUTORS IN U. S. AND POSSESSIONS

### AMERICAN AUTOMATIC ELECTRIC SALES COMPANY

1033 West Van Buren Street, Chicago, U.S.A.

#### BRANCH SALES OFFICES

New York, N. Y.	Kansas City, Mo.	Los Angeles, Calif.	Cleveland, Ohio	Pittsburgh, Pa.
Boston, Mass.	Detroit, Mich.	San Francisco, Calif.	Washington, D. C.	Philadelphia, Pa.

#### WAREHOUSES

Chicago, Ill.	Richmond, Va.	Kansas City, Mo.	San Francisco, Calif.	Dallas, Tex.
---------------	---------------	------------------	-----------------------	--------------

#### ASSOCIATED MANUFACTURERS

Phillips Electrical Works Limited	- - - - -	Brockville, Ont., Canada
Automatique Electrique, S.A.	- - - - -	Antwerp, Belgium
Automatic Telephone & Electric Co., Ltd.	- - - - -	Liverpool, England
Autelco Mediterranea S.A.T.A.P.	- - - - -	Milan, Italy

#### GENERAL EXPORT DISTRIBUTORS

### AUTOMATIC ELECTRIC SALES COMPANY, LIMITED

1027 West Van Buren Street, Chicago, U.S.A.

#### ASSOCIATED DISTRIBUTING COMPANIES AND RESIDENT SALES REPRESENTATIVES

##### Argentina

Luis Pitigliani, 25 de Mayo 489, Buenos Aires

##### Australia

Automatic Electric Telephones Limited, Sydney

##### Belgium

Automatic Electric Sales Company, S.A., Antwerp.

##### Brazil

Automatic Telephones Limited of Brazil, Sao Paulo

##### Canada

Canadian Telephones & Supplies Limited, Toronto.  
Branches—Montreal, Winnipeg, Regina, Vancouver,  
Brockville, Edmonton, and Calgary

##### China

Automatic Telephone Company of China, Shanghai

##### Colombia

Importaciones Automaticas Electricas de Colombia,  
S.A., Bogota

##### Egypt

Automatic Electric Sales Company, S. A., Cairo

##### India

Automatic Telephone & Electric Co. Ltd., Calcutta

##### Italy

Autelco Mediterranea S.A.T.A.P., Milan

##### Japan

Automatic Telephones, Limited, of Japan, Tokyo

##### Mexico

Efrain Campos N., Madero 42, Mexico, D.F.

##### Netherlands East Indies

H. S. Janes, c/o N. V. Industrieele Mij. Gebr. van  
Swaay, Katja 2—Wetan 80A, Bandoeng, Java

##### Philippine Islands

Automatic Electric Sales Company, Limited, Manila

##### Turkey

L. Deroisy, c/o Messrs. Kemal Halil Tanir Mehmet  
Rifat Yalman & Co., Tatko Company, Opposite  
Taksim Garden, Istanbul

##### Yugoslavia

Autelco A.D., Belgrade

*Other Sales Representatives and Agents Throughout the World*

## Ordering Information

### Orders

Orders for shipment within U. S. and possessions should be placed on American Automatic Electric Sales Company, 1033 W. Van Buren Street, Chicago, Illinois. Orders for foreign shipment should be placed on Automatic Electric Sales Company, Limited, 1027 W. Van Buren Street, Chicago, Illinois, U. S. A.

When ordering, give quantity desired, catalog number and description as shown in catalog. If there is any doubt as to the exact instrument required for any purpose, please provide us with complete details regarding its application. Our Engineering Department will then be in a position to enter your order properly, and without unnecessary correspondence.

### Special Apparatus

When ordering special apparatus, please give the catalog number of a similar standard item listed herein (this will enable our Engineering Department quickly and accurately to determine the general type of apparatus desired) and then specify in detail the variations desired from this standard assembly.

### Shipments

Shipments will be made in accordance with instructions received with order. Please specify method of shipping, and give preferred routing. In the absence of instructions, we will use our best judgment in routing shipments to give you the very best service.

### Claims

We assume no responsibility for breakage or loss after receiving an "In Good Order" receipt from the transportation company, and all claims of this kind

should be made direct to them without delay. We will be glad to cooperate in securing satisfactory adjustment of such claims. Mail shipments of considerable value are insured, at the customer's expense.

Claims for shortage should be made promptly, and should be accompanied by packer's ticket, which is placed in each case.

If it is desired to return goods for credit, exchange or repairs, please secure our consent and shipping instructions before shipping.

### Prices

Price lists are issued from time to time, and the current list will be gladly sent upon request. Unpriced orders will be filled at prices prevailing at date of shipment. Small orders priced from obsolete price lists will be shipped at latest prices without re-quotation, unless revised quotations are requested before shipment. Large orders so priced will be quoted on, and your approval secured before shipment is made.

### Terms

Accounts with companies with approved credit are payable net 30 days from date of invoice, except where quotations indicate otherwise.

New credit accounts are solicited. In order to facilitate prompt shipment, send references or other information of a credit character with your order, if you are not rated by the commercial agencies. If it is desired to avoid delay on your first order incidental to communicating with references, etc., instruct us to ship C.O.D. by express or parcel post, or by freight, subject to sight draft through a local bank against the bill of lading.

## GUARANTEE

*Apparatus manufactured by Automatic Electric Company is guaranteed to be free from mechanical and electrical defects, and any part or unit which proves defective under normal conditions, and when used as intended, will be replaced or repaired without charge, if returned to our general offices within one year. Apparatus of other makes bears the standard guarantee of the manufacturer. Please secure our consent and shipping instructions before returning goods for replacement or repair.*

## A Complete Line of Telephones, Telephone Parts and Accessories

In the Automatic Electric line of telephone instruments and associated apparatus, the telephone company or administration operating any type of equipment—automatic or manual, central-battery or magneto—will find substation apparatus to meet practically every need. A wide selection of this apparatus is presented in this catalog—standard telephones and accessories adapted to almost all requirements of public and private service.\*

In the development and manufacture of all Automatic Electric apparatus, we have kept constantly in mind the requirements of the telephone company, and the telephone user. Transmission apparatus of the very finest is combined with circuits specifically designed to secure the highest quality of transmission from this apparatus, and the best overall performance from your lines. And generous design in every detail provides an ample margin of safety against failure, even under severe operating conditions.

### The Type 24A36 Dial

Automatic telephones are supplied with the Automatic Electric Type 24A36 dial, which is world-famous for its almost unbelievably long life, and its ease and quietness of operation. The dial is regularly supplied with the standard number card, round finger

plate, and "1" to "0" number plate shown in the illustrations, but other designs are available, as described under the various telephone listings.

### Adapted for Conversion

If you operate manual equipment, you will find the "conversion" feature of Automatic Electric telephones of particular value. Central-battery manual telephones shown in this catalog are regularly fitted with "dial blanks", in the space provided for the dial. Thus, any such telephone can be converted to automatic operation at any time, by removing the dial blank, and mounting and connecting the dial.

### For any Method of Ringing

Automatic Electric central-battery telephones are available with ringing equipment to meet any requirements. Ringing may be metallic or grounded, with polarized ringers of either the "straight-line" ("untuned") type (for single-party metallic ringing, two-party divided ground ringing or code ringing), or of the harmonic type in any of the standard frequencies. Ringers of the "straight-line" type are provided with a biasing spring to prevent tinkling on circuit transients such as may be caused during dialing.

## \*Special Telephones for All Purposes

This catalog does not include the many special telephones and telephone systems offered by Automatic Electric to meet unusual requirements in specialized fields. Made to Automatic Electric high quality standards, these instruments and systems include:

*Explosion-Resisting Telephones*—Telephone instruments and associated apparatus assembled in sturdy cast-metal cases, and approved by Underwriters' Laboratories, Inc., for use in hazardous locations, exposed to explosive dusts and gases. All current-carrying parts are enclosed, and cases are of ample strength to withstand explosions which might occur within them.

*"Railroad" Telephones*—with special circuits and equipment, as required for use on railroad dispatchers' lines, and for pipe line, oil field, and other similar telephone systems.

*Sound-Powered Telephones*—Using only the power supplied by the voice, these telephones will transmit clear, intelligible speech, over lines of any length up to 200 miles or more, without battery or other source of transmission current. For use on long private lines where no switching equipment is required; also, for temporary lines, as for construction projects, surveying, etc. Instruments for marine navigational service are also available.

*Carrier-Current Telephones*—Standard types of automatic Monophones, especially equipped for use with General Electric Company single-frequency equipments, Types KCA-1, KCA-3, and CC-8B.

Ask for complete information on any of these special systems and instruments in which you are interested.

## Automatic Electric Telephones Have "User Appeal"

In recent years, telephone companies have given increasing attention to the part which can be played by modern telephone apparatus as a means of attracting subscribers, and of securing their goodwill. These companies have found that telephone instruments of pleasing appearance, and offering the utmost in convenience and in transmission quality, are of definite help in "selling" telephone service.

This attention now being given to "user appeal" in telephone apparatus had its beginning in 1925, when Automatic Electric Company introduced the Monophone. This new instrument—the first practical telephone of the modern handset type—represented also the first successful attempt to build into telephone apparatus the beauty and convenience which would appeal to telephone users.

Constantly considering the subscriber's viewpoint, Automatic Electric has pioneered many of the most important recent developments in telephone apparatus. They were first, for example, with a desk telephone of the modern "self-contained" type which has become so popular among telephone users. The first wall telephone of the modern handset type (which makes it unnecessary for the user to stay close to the telephone, and thus eliminates a great disadvantage of former wall telephones) was also offered by Automatic Electric Company. Throughout this catalog will be found additional evidence of continued attention to such features of "user appeal."

### Instruments of Quality

The appearance and convenience of Automatic Electric telephones are backed by very evident *quality*. All parts are sturdy and substantial, and are solidly mounted. Finishes are handsome and durable, and highly resistant to wear and abuse.

These are instruments you will be proud to install. And once installed, Automatic Electric telephones will serve as a continual source of goodwill for any telephone company or operating administration.

### Telephones in Color

To satisfy the modern desire for color in the home or office, Automatic Electric Company offers several

of its most modern instruments in a range of beautiful art shades. These colors were selected, after careful study of color harmonies, and investigation of popular preferences, as best meeting the widest possible variety of conditions. The colors are part of the molding material itself, and cannot chip or wear off.

The colors available in the various types of Monophones are listed under the descriptions herein. These colors include:

Mahogany—reddish brown, grained in black in simulation of highly polished mahogany.

Walnut—brown, with black grain closely resembling polished dark walnut.

Black—with gold or chromium trim, makes an instrument of dignified beauty.

Chinese Red—the beauty of brilliant red lacquer reproduced in molded plastic.

Old Ivory—a rich ivory, suggested particularly for use in bedrooms, living rooms, etc.

Jade Green—bright green, especially attractive when trimmed in gold.

Nile Green—a light "pastel" green, for bedrooms, kitchens, etc.

Royal Blue—dark powder blue, particularly handsome with chromium trim.

Orchid—pale lavender, particularly appropriate for use as a bedside telephone.

Maroon—deep, dark red, of striking beauty when trimmed in gold.

The metal fittings of these instruments are available in either heavy chromium plate, highly polished, or in heavy pure gold plate with a satin finish.

### Telephone Accessories

To further increase the convenience of telephone service, and the subscriber's enjoyment and use of his telephone, we offer in this catalog a number of telephone accessories. These accessories are being used by telephone companies desiring to provide the most up-to-date and convenient facilities for telephone service. Their value as goodwill builders is proved; at the same time, they serve the telephone company as a ready source of increased revenue.

# YOUR TELEPHONE IN *Color*



NILE GREEN & CHROMIUM



JADE GREEN & GOLD



MAROON & GOLD



ORCHID & CHROMIUM



MAHOGANY & GOLD



OLD IVORY & GOLD



ROYAL BLUE & CHROMIUM



WALNUT & CHROMIUM

★ To those who appreciate the brilliance and beauty of color in their homes and offices, we offer these modern handset telephones in smart and attractive colors. Skilfully molded from colored plastic, with gold or chromium-plated trim, these beautiful instruments are artistic as well as practical contributions to modern living. Recommendations for particular applications will be gladly supplied on request.

CHINESE RED & GOLD



# FOUR MODERN MONOPHONES

## 18 Color Combinations



The Type 50 Wall-Mounting Monophone



The Type 1A Desk Monophone



A Typical 2-Line Monophone

All of the popular types of Monophones are available in a range of color combinations which have been carefully selected to meet a wide variety of conditions. Because colored Monophones are *molded* of high-grade plastics, the color is permanent—cannot chip or wear off. Refinishing costs are avoided. Metal trim is beautifully finished in durable, non-tarnishing satin gold or polished chromium plate, as preferred. And the black Extensicord on the Monophone handset gives added distinction.

From the four modern designs and the many striking color combinations offered, you can select an instrument which will fit perfectly—both in style and in color—into any surroundings. All models are available either with dial for use with automatic equipment, or with dial blank for use with manual exchanges.

### FOUR POPULAR TYPES

**THE TYPE 40 DESK MONOPHONE** (shown on the reverse side of this sheet) is our newest desk Monophone, with capsule transmitter and receiver, and new balanced transmission circuit. Supplied in all color combinations. *When ordering, specify: 1. Color and trim; 2. automatic or manual; 3. ground or metallic ringing; 4. ringer frequency, if harmonic.*

**THE TYPE 50 WALL MONOPHONE** is a wall-type companion to the Type 40, using the same handset and other principal components. Supplied in Walnut, Mahogany, Chinese Red, Jade Green, and Old Ivory, with gold- or chromium-plated trim. *When ordering, specify: 1. Color and trim; 2. automatic or manual; 3. ringer frequency, if harmonic.*

**THE TYPE 1A DESK MONOPHONE** is used where an especially compact and light weight desk stand is required and a separate ringer box is not objectionable. Supplied in all color combinations. *When ordering, specify: 1. Color and trim; 2. automatic or manual.*

*Note: The above desk stand must be used with a ringer box having a three-winding induction coil. If ringer box is desired, order separately and specify: 1. Plastic or metal; 2. metallic or ground ringing; 3. ringer frequency, if harmonic. (Ringer boxes are available only in black.)*

**TWO-LINE MONOPHONES** provide facilities for making or answering calls on either of two lines with a single desk telephone, and afford provisions for holding one connection while talking over the other. For details of the various available switching arrangements, ringer boxes, etc., see our general catalog of telephones. *When ordering Two-line Monophones in color, specify: 1. Catalog number of corresponding black instrument. 2. Color and trim. Order ringer boxes separately.*

# AUTOMATIC ELECTRIC

MAKERS OF TELEPHONE, SIGNALING AND COMMUNICATION APPARATUS  
ELECTRICAL ENGINEERS, DESIGNERS AND CONSULTANTS

Distributors in U. S. and Possessions:

AMERICAN AUTOMATIC ELECTRIC SALES COMPANY, 1033 West Van Buren Street, Chicago, U.S.A.

Export Distributors: AUTOMATIC ELECTRIC SALES COMPANY, LIMITED, Chicago



## Two Brilliant New Monophones

On the following pages, Automatic Electric proudly presents two recent developments in the Monophone line—desk and wall instruments which have proved their ability to meet the demands of the most critical users and operating executives. Their ease and convenience of handling, their clearness and fidelity of transmission, and their general technical performance under a wide range of operating conditions, all testify to an excellence that is thoroughly in accord with today's demands.

These brilliant new Monophones have been made possible by the development of a Monophone handset which offers new smooth-flowing lines and improved balance for greatest ease of handling—a new “all positions” transmitter and a “damped-diaphragm” receiver for clear and lifelike transmission—and an “anti-sidetone” circuit which assures a proper balance in transmission and reception levels under an extremely wide range of operating conditions.

### The “All-Positions” Transmitter

The new “capsule type” transmitter provides transmission output of remarkable uniformity, in whatever position it may be held, and over the entire range of voice volumes and frequencies in ordinary speech.

Its entire response curve is free from high peaks at any frequency, and high-frequency cut-off occurs above the 3500-cycle level. Volume output is high, and follows closely all variations in the volume of impressed speech.

The carbon cell which provides this high transmission efficiency has hemispherical carbon cups and circular electrodes, which result in uniformly low resistance in all positions. This assures low carbon noise and long life, and exceptional “all-positions” characteristics.

The “all-positions” transmitter is well adapted for use under conditions of extreme humidity, all working parts being tightly sealed. Even after actual immersion in water, it continues to operate without noticeable loss of efficiency. And its characteristics are such that it may be used at any point on lines of any ordinary length. It is not necessary to change transmitters to adapt the Monophone to its particular location on the line.

### The “Damped-Diaphragm” Receiver

The “damped-diaphragm” capsule type receiver used in these new Monophones provides exceptionally uni-

form response, with negligible variation over the entire range of frequencies between 300 and 3000 cycles. Such accurate response provides high-fidelity reproduction of the voice, and low apparent sidetone, besides improving reception over high-attenuation circuits (in which the response through previous types of receivers is sharply reduced at high frequencies). It also reduces the possibility of acoustic shock due to circuit transients.

### The New Anti-Sidetone Circuit

The combination of the new transmitter and the new receiver gives a response which increases gradually over the range from 300 to 3000 cycles, thus compensating for the greater attenuation of high frequencies in aerial and underground cables. Through the use of a new circuit, the characteristics of the transmitter and receiver are coordinated with a new induction coil which makes it possible to take full advantage of this improved transmission on circuits of high attenuation, without the unpleasantness of too much volume or sidetone on circuits of low attenuation. The new circuit includes also a suppression network, which is effective during dialing, to reduce radio-frequency radiation.

Laboratory tests, as well as the experience of telephone operating companies, prove that the transmission provided by this combination of transmitter, receiver, induction coil, and circuit, meets the most exacting requirements in the field. We invite all operating organizations to test these new Monophones on their own lines under actual working conditions, and to make any other desired tests. We are confident that such tests will demonstrate the faithfulness of reproduction provided by these Monophones, the striking reduction in sidetone, and the ample transmission volume which results from our exclusive circuits and mechanical designs.

### “Standard” and “Super-Volume”

The circuit and equipment of these new Monophones are designed and balanced to provide high transmission volume and fidelity over a wide range of operating conditions. For use on exceptionally long lines, or to meet operating conditions of unusual severity, a special “super-volume” all-positions transmitter with special mouthpiece, and a special induction coil, can be supplied—the combination providing extra transmission output.

## The Type 40 Desk Monophone

This new "self-contained" Monophone has striking modern lines which make it appear well in any surroundings. Finger grips in the sides of the case afford new convenience in lifting. New sturdiness is provided by the design of the handset and base moldings, by twin contacts on the cradle switch springs, by durable cords on handset and desk stand—all features designed to assure long and trouble-free life. And the new circuit and new transmission components (described on page 7) provide high transmission quality and volume over the widest range of line conditions.

### A Self-Contained Telephone

The Type 40 Monophone is of the self-contained type, which is so popular with subscribers and telephone companies because it requires no ringer box. The complete instrument consists of the desk stand, the Type 41 Monophone handset with cord, and a 6-foot desk stand cord fitted with a small and neat connecting block, molded of black plastic, for connection to the telephone line.

The desk stand is molded of high-grade black plastic, and equipped with a heavy pressed steel baseplate with a rubber cushion ring. Decorative finger grips molded into the sides of the cradle afford easy lifting, with two or three fingers of one hand, from the front, side, or rear, with the handset held securely in place. The fingergrrips also add a pleasing motif to the sides of the molded case. Sound openings are molded in the sides of the case and are lined with screening to exclude insects.

### New Equipment Components

All components are of the highest quality and modern design. The ringer has powerful, full-sized mechan-

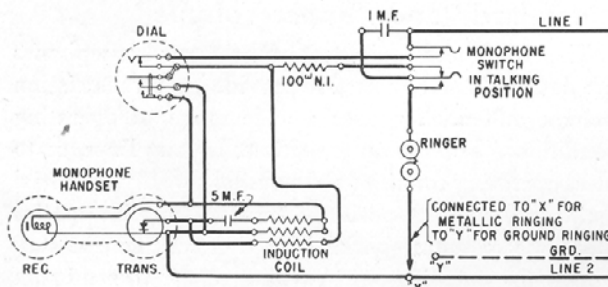

New Anti-Sidetone Circuit Used in the Type 40 Monophone



ism, and gongs of two different tones, producing a signal which is pleasing to the ear and carries easily through surrounding noises. The ringer is cradled in live rubber.

The Monophone cradle switch has phosphor bronze springs, and, for maximum contact reliability, employs twin contacts.

The Monophone handset is molded of black plastic, in simple lines which follow closely the lines of the desk stand itself. The transmitter and receiver are of the capsule type, inserted by merely slipping them into place, and readily removable without opening wire connections. The receiver conductors are molded in the handle.

Desk-stand and handset cords are of Monotype construction, and are covered with durable black braid, which will retain its handsome appearance through a long life.

### New Anti-Sidetone Circuit

The combination of new transmission components in the anti-sidetone circuit shown at left results in

## The Type 40 Desk Monophone

exceptional transmission efficiency, properly coordinated to provide high-quality performance over a wide range of line conditions.

*Dimensions*—Height, 5¼ in.; width of base, 5½ in.; depth of base, 8¼ in. The handset is 9 in. long.

*Net Weight*—6 lbs. *Shipping Weight*—13 lbs.

ATTRACTIVE PRINTED CIRCULARS, suitable for enclosing with subscribers' statements, etc., are available without charge to any telephone company desiring to promote installation of Type 40 Monophones. Ask for samples of these circulars—or tell us how many you will require for distribution (please be sure to specify whether automatic or manual instruments).

### Condensed Specifications and Catalog Listing



Type 40 Monophone—Automatic  
Cat. Nos. AA-50 and -51

#### Cat. No. AA-50—Type 40 Monophone—Automatic—Metallic Ringing

With black plastic case, and chromium-plated dial finger plate and transmitter and receiver bands. Type 24A36 dial has finger plate, number card, and "1" to "0" number plate as shown. Polarized ringer with biasing spring, for straight-line or code ringing. Monophone handset with Monotype cord, 53 inches long. Two-conductor desk-stand cord, and 1-pair connecting block, for metallic ringing.

#### Cat. No. AA-51—Type 40 Monophone—Automatic—Ground Ringing

As above, but with 3-conductor desk-stand cord, and 2-pair connecting block, for ground ringing.

#### Cat. No. AA-52—Type 40 Monophone—Man., Conv.—Metallic Ringing

Like Cat. No. AA-50, above, but has black plastic dial blank, with number card and chromium-plated card ring, as shown. All wiring for dial is provided (with impulse spring leads connected together), permitting conversion to automatic operation by merely removing the blank and adding the dial. Two-conductor desk-stand cord, and 1-pair connecting block, for metallic ringing.



Type 40 Monophone—Man., Conv.  
Cat. Nos. AA-52 and -53

#### Cat. No. AA-53—Type 40 Monophone—Man., Conv.—Ground Ringing

As above, but with 3-conductor desk-stand cord, and 2-pair connecting block, for ground ringing.

#### Harmonic Ringing

The above catalog numbers cover Monophones with straight-line ringers. If harmonic ringer is desired instead, give catalog number of corresponding instrument having straight-line ringer, and state frequency desired.

#### Modifications

The Type 40 Monophone offers a range of optional features to meet all operating requirements and subscribers' preferences:

*Lift Handle*—A chromium-plated lift handle is supplied on request. This handle drops out of sight behind the cradle when not in use, and provides a most convenient means of carrying the instrument about—for considerable distances, if necessary.

*Extensicord*, the "stretchable" handset cord (see page 40), can be supplied instead of the standard handset cord, if specified.

*Other number cards or plates* can be supplied. If desired, please give catalog numbers (see page 34).

"Cutaway" dial finger plate (see page 34) can be supplied instead of round plate. If desired, please specify.

*Colored Monophones*—Where a truly "de luxe" instrument is desired, the Type 40 Monophone can be supplied with molded parts in colored plastic, and metal trim finished in polished chromium or satin gold. These instruments are fitted with black Extensicord instead of standard handset cord. The following colors are available: Black and gold; Mahogany, Walnut, Chinese Red, Old Ivory, Jade Green, Orchid, Nile Green, Royal Blue, and Maroon, with gold or chromium. When ordering, specify color and trim desired.

*"Super-Volume"*—For use on very long lines, or to meet very severe operating conditions, the Type 40 Monophone can be supplied with super-volume "all-positions" transmitter, cupped mouthpiece, and special anti-sidetone induction coil—this combination providing extra transmission output. If desired, specify "Super-Volume." (This instrument is available only in black).

*A Portable Telephone*—With its convenient finger grips and chromium-plated lift handle (optional), the Type 40 Monophone is ideally adapted for use as a portable telephone. Use Portable Telephone Plug AZ-10, Jack AZ-11 (see page 42).

For Replacement Parts for the Type 40 Desk Monophone, see page 45

## The Type 50 Wall-Mounting Monophone

Here is a wall telephone which is headed for a new high in popularity—among telephone users as well as telephone men. This new instrument combines the advantages of wall mounting with the convenience of the Monophone handset, and beauty which is at home in any surroundings. It may be mounted at any height, convenient for use from either a sitting or standing position, and, if desired, out of reach of small children.

To the operating company, the Type 50 Monophone offers ease of installation, ready accessibility of all parts—and the convenience and economy of using standard parts which are interchangeable with those of the Type 40 Desk Monophone.

### Many Quality Features

The Type 50 Wall-Mounting Monophone is cased in lustrous black plastic, with metal trim brilliantly finished in polished chromium plate. Its distinctive design harmonizes with the simple lines of the Type 41 Monophone Handset, which, resting on the horizontal cradle, is presented in position for ready use. The unique handset mounting provides secure cradling of the handset.

The Type 50 Monophone is designed for long life and low maintenance cost. Molded parts are shaped for light weight and great strength; twin contacts on the cradle switch springs provide greater reliability; Monotype handset cord minimizes "cord trouble."

All working parts of the Type 50 Wall-Mounting Monophone, including the cradle switch, are mounted on the black plastic backplate. The cover is readily removable by unscrewing the cradle switch plunger (using tool AW-17, page 44), and loosening the two cover-retaining screws. Cover has sound openings at

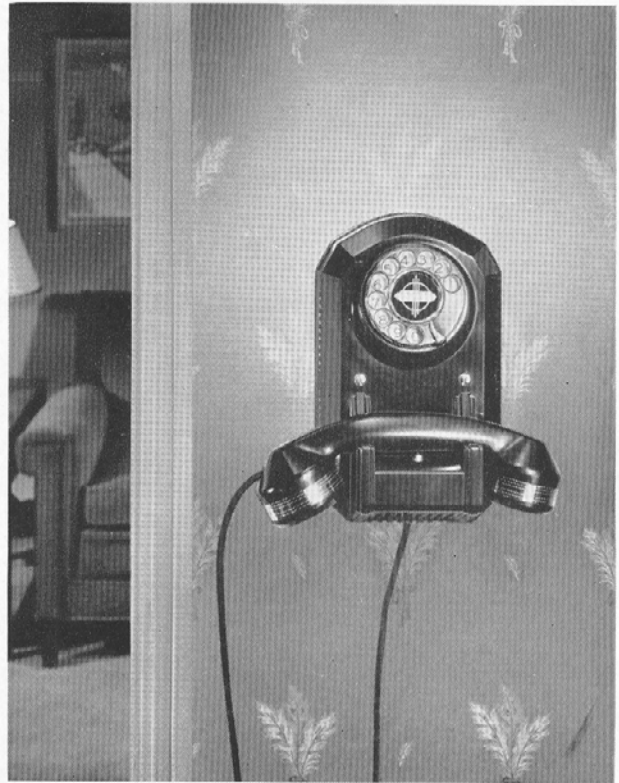

sides and bottom, covered with screening to exclude insects.

The apparatus on the backplate consists of the ringer, talking and ringing condensers, induction coil, cradle switch, Type 24A36 dial (on automatic models), and all terminals and wiring. (On manual models, the molded plastic dial blank is fastened to the cover). Mounting holes in the backplate are left covered with thin knockouts, and holes may be knocked out as required, to permit secure fastening on any type of wall.

The ringer is mounted in live rubber, and is fitted with two-tone gongs, which provide a signal of pleasing quality, with exceptional power of penetration through surrounding noises. A terminal is provided for ground connection, and ground ringing is provided by merely moving one ringer connection to this terminal, at the time of installation.

The Monophone handset has capsule-type "all-positions" transmitter, and capsule-type, damped-diaphragm receiver. These units are combined with the special "short-air-gap" induction coil in an efficient

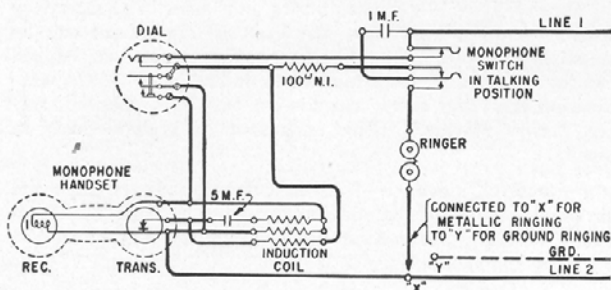

New Anti-Sidetone Circuit Used in the Type 50 Monophone

## The Type 50 Wall-Mounting Monophone

anti-sidetone circuit which is designed and balanced to provide high transmission quality and volume over a wide range of operating conditions.

*Dimensions*—Height,  $9\frac{1}{2}$  in.; width,  $5\frac{3}{4}$  in.; depth,  $5\frac{1}{4}$  in. The handset is 9 in. long.

*Net Weight*— $6\frac{1}{4}$  lbs.

*Shipping Weight*—13 lbs.

ATTRACTIVE PRINTED CIRCULARS, suitable for enclosing with subscribers' statements, etc., are available without charge to any telephone company desiring to promote installation of Type 50 Monophones. Ask for samples of these circulars—or tell us how many you will require for distribution (please be sure to specify whether for automatic or manual instruments).

### Condensed Specifications and Catalog Listing



Type 50 Monophone—  
Automatic. Cat. No. AA-60

#### Cat. No. AA-60—Type 50 Monophone—Automatic

With black plastic case, and chromium-plated dial finger plate and transmitter and receiver bands. Type 24A36 dial has finger plate, number card, and "1" to "0" number plate, as shown. Polarized untuned ringer with biasing spring, for straight-line, divided, or code ringing. Monophone handset with Monotype cord, 53 inches long, covered with durable black braid. The Type 50 Monophone may be connected either for metallic or for ground ringing.

#### Cat. No. AA-61—Type 50 Monophone—Manual, Conv.

Like Cat. AA-60, above, but has black plastic dial blank, with number card and chromium-plated card ring, as shown. All wiring for dial is provided (with impulse spring leads connected together), permitting conversion to automatic operation by merely adding the dial.



Type 50 Monophone—  
Man., Conv. Cat. No. AA-61

#### Harmonic Ringing

The above catalog numbers cover Monophones with straight-line ringers. If harmonic ringer is desired, instead, give catalog number of corresponding instrument having straight-line ringer, and state frequency desired.

#### Modifications

The Type 50 Monophone offers a range of optional features to meet all operating requirements and subscribers' preferences:

*Extensicord*, the "stretchable" handset cord (see page 40), can be supplied instead of the standard handset cord, if specified.

*Other number cards or plates* can be supplied. If desired, please give catalog numbers, (see page 34).

*"Cutaway" dial finger plate* (see page 34) can be supplied instead of round plate. If desired, please specify.

*Colored Monophones*—Where a truly "de luxe" instrument is desired, the Type 50 Monophone can be supplied with molded parts in colored plastic, and metal trim finished in

polished chromium or satin gold. These instruments are fitted with black Extensicord instead of standard handset cord. The following colors are available: Black with gold-plated trim; Mahogany, Walnut, Chinese Red, Old Ivory, or Jade Green, with gold or chromium-plated trim. When ordering, specify color and trim desired.

*"Super-Volume"*—For use on very long lines, or to meet very severe operating conditions, the Type 50 Monophone can be supplied with super-volume "all-positions" transmitter, cupped mouthpiece, and special anti-sidetone induction coil—this combination providing extra transmission output. If desired, specify "Super-Volume". (This instrument is available only in black.)

#### Conduit Adapter

An adapter is available for mounting the telephone on a standard 4-inch outlet box if the telephone wiring is to be run in conduit.

**Cat. No. AW-28—Adapter for Outlet-Box Mounting**

For Replacement Parts for the Type 50 Wall-Mounting Monophone, see page 46.

## The Type 1A Desk Monophone



Type 1A Monophone—Automatic  
Cat. No. AA-18



Type 1A Monophone—Man., Conv.  
Cat. No. AA-19

While this type of desk stand, which requires a separate ringer box, is being replaced for many purposes by "self-contained" instruments (such as the Type 40 Monophone), many users prefer it for its lightness, compactness and portability. Women often consider the Type 1A Monophone most convenient as a bedside telephone, because it can be readily lifted from the table for dialing. The Type 1A Monophone is also ideally adapted for use at stations where the Monochime (see page 30) is to be used. And, for extension stations where a signal is not needed, this small, lightweight instrument may be combined with a Type 32 Compact Extension Box (see page 31) to provide maximum convenience in a minimum of space.

### Compact—Lightweight—Handsome

The Type 1A Desk Monophone is molded of high-grade plastic, for light weight, great strength, and handsome, permanent finish. The handset cradle is mounted back of the center of the base, and the dial is set into the base with only the finger plate and finger stop projecting above the surface. This places the dial at a convenient angle for operation, helps to protect it from damage, and permits access to the rear of the dial, for inspection or adjustment, without removing it from its mounting. The pressed steel baseplate is removed by simply loosening one screw, and this exposes the rear of the dial, the terminal block (molded as an integral part of the base), and the connections to the handset, the cradle switch, and the desk stand cord.<sup>a</sup> A black rubber cushion ring on the baseplate protects highly polished surfaces.

The Monophone switch is mounted in the handset cradle, and is actuated through a compound-acting plunger which assures positive operation even if the

handset cord should accidentally fall across the cradle when the handset is replaced. Switch springs are of heavy-gauge phosphor bronze, providing ample pressure for positive, non-microphonic contact. A metal dust-cover protects the switch and is readily removable (using tool AW-17, page 44) for inspection of the springs and contacts.

The dial provided on automatic models is the Type 24A36 "quieted pawl" dial, which is famous for its smooth and practically noiseless operation. On manual, convertible models, the dial is replaced with a dial blank, with number card and black-japanned card ring, as shown.

### Efficient Anti-Sidetone Circuit

The Type 1A Desk Monophone is regularly supplied for use with a ringer box containing a three-winding induction coil, in the anti-sidetone circuit shown here-

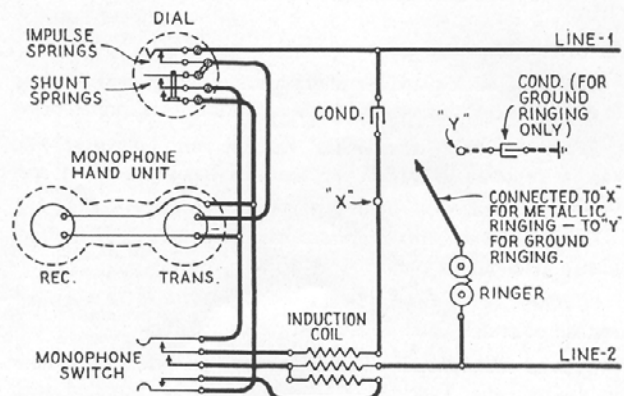

Circuit of Type 1A Monophone and  
Associated Ringer Box

## The Type 1A Desk Monophone

with. The handset contains an "all-positions" transmitter, and a polarized receiver, and is fitted with a Monotype cord, 53 inches long, covered with durable brown braid. A 6-foot Monotype cord is provided, for connection to the ringer box.

*Dimensions*—Height, 5 inches; diameter of base,  $5\frac{5}{8}$  inches. The handset is 9 inches long.

*Net Weight*— $3\frac{1}{2}$  lbs.

*Shipping Weight*—6 lbs.

### Condensed Specifications and Catalog Listing

#### Cat. No. AA-18—Type 1A Monophone—Automatic

For use with ringer box, Monochime or extension box having 3-winding induction coil. Black plastic case, and black-japanned dial finger plate, and transmitter and receiver bands. Monophone handset contains "all-positions" transmitter, and polarized receiver, and is equipped with Monotype cord, 53 inches long, covered with durable brown braid. Desk stand equipped with Type 24A36 dial, with finger plate, number card and "1" to "0" number plate, as shown. Four-conductor, brown, Monotype desk-stand cord, 6 feet long, is provided for connection to the ringer box. *Order ringer box separately* (see below).

#### Cat. No. AA-19—Type 1A Monophone—Man., Conv.

Like Cat. No. AA-18, above, but with molded plastic dial blank instead of dial, and dial wiring omitted, impulse spring leads being replaced by a direct connection. *Order ringer box separately* (see below).

#### Induction-Coil-Receiver Circuit

If it is desired to replace old types of telephones with the Type 1A Monophone, without discarding the existing ringer boxes, the Type 1A Monophone can be supplied with an induction-coil receiver, which makes it unnecessary to provide a separate induction coil. This instrument can be used in connection with any conventional ringer box containing a ringer and a condenser (for metallic ringing) or two condensers (for ground ringing). If desired, give catalog number of corresponding instrument shown above, and specify "induction-coil-receiver circuit."

#### Modifications

*Extensicord*, the "stretchable" handset cord (see page 40), can be supplied instead of the standard handset cord, if specified.

*Other number cards or plates* can be supplied. If desired, please give catalog numbers (see page 34).

"*Cutaway*" dial finger plate (see page 34) can be supplied instead of round plate. If desired, please specify.

*Colored Monophones*—The Type 1A Desk Monophone is also available in Black, Walnut, Mahogany, Chinese Red, Old

Ivory, Jade Green, Nile Green, Royal Blue, Orchid, or Maroon, with metal trim gold- or chromium-plated. These instruments are fitted with black Extensicord instead of standard handset cord, and desk stand cord has black braid covering. When ordering, specify color *and trim* desired.

*Metal Base and Cradle*—If desired, desk stand can be furnished with black-japanned brass base, and aluminum alloy cradle, instead of molded plastic.

*A Portable Telephone*—The Type 1A Desk Monophone is adapted for use as a portable telephone, using Portable Telephone Plug AZ-12, Jack AZ-13 (see page 42).

#### Ringer Boxes for Type 1A Monophones

Metal ringer boxes are of conventional size and design, with base and cover of steel, finished in heavy black japan. Dimensions are: height,  $9\frac{3}{4}$ "; width,  $7\frac{1}{4}$ "; depth, 4". (For illustration, see page 29).

Type 32 Compact Ringer Boxes are molded of black plastic, and are only about one-half as large as metal ringer boxes. Dimensions are: height,  $7\frac{1}{4}$ "; width,  $5\frac{1}{2}$ "; depth,  $2\frac{5}{8}$ ". Sound holes, in the bottom of the box, are lined with fine-mesh screen, to keep out insects. (For illustration, see page 29).

#### Catalog Number

<i>Metal</i>	<i>Type 32</i>	<i>Description</i>
AO-17	AO-11	Anti-Sidetone—Metallic Ringing
AO-18	AO-12	Anti-Sidetone—Ground Ringing

#### Harmonic Ringing

The above catalog numbers cover ringer boxes with straight-line ringers. If harmonic ringer is desired instead, give catalog number of corresponding ringer box having straight-line ringer, and state frequency desired.

**For Monochimes and Extension Boxes** suitable for use with the Type 1A Monophone, see pages 30 and 31.

For Replacement Parts for the Type 1A Desk Monophone, see page 47.

## “Two-Line” Monophones



“Two-Line” Monophone—Automatic  
Cat. No. AA-22



“Two-Line” Monophone—Manual, Convertible  
Cat. Nos. AA-25 and AA-27

“Two-Line” Monophones provide, in convenient and very attractive form, the facilities required for “double-track” service, executive-secretarial service, and other similar switching services. These special services are of great value for subscribers who need more than one telephone, but who cannot justify the installation of a private exchange. Telephone users appreciate the convenience of such switching facilities, and “Two-Line” Monophones make it possible to provide them, without the use of separate switch boxes, desk keys, etc. For use in the finest executive offices, these instruments are available in the entire range of art shades.

A “Two-Line” Monophone consists of a Type 1A Monophone combined with a sub-base which contains key equipment for connecting the telephone to either of two telephone lines, and, if desired, for “holding” a connection on one line while talking on the other. The “holding” keys, when provided, are mechanically linked to the handset cradle switch, and are restored when the handset is replaced in the cradle. For this reason, a small pushbutton is provided in the top of the sub-base, and is used instead of the cradle switch, for releasing a connection in case it is desired to dial a second time on one line while holding a call on the other, or for recalling the operator in a manual system.

“Two-Line” Monophones are available with various key equipments and circuit arrangements as described below. Each instrument is equipped with Monophone switch, 6-foot Monotype desk stand cord, and Monophone handset with “all-positions” transmitter and 3-conductor Monotype handset cord, 53 inches long. Type 24A36 dial, with finger plate, number card and “1” to “0” number plate as shown, is provided on automatic models; molded plastic dial blank, with

number card and black japanned card ring, as shown, on manual convertible models. Desk stand and handset cords covered with brown braid.

Handset and base are molded of high-grade black plastic, with transmitter and receiver bands and dial finger-plate heavily black japanned, dial finger stop polished chromium plate, and switching keys polished nickel plate.

“Two-Line” Monophones are wired in accordance with the anti-sidetone circuit used in the Type 1A Monophone (see page 12), and are to be used with ringer boxes as listed on page 15.

A booklet describing various applications of “Two-Line” Monophones, and including circuits and other installation data, will be gladly sent on request.

*Dimensions*—Height, 6¼ in.; diameter of base, 6⅜ in. The handset is 9 in. long.

*Net Weight*—5 lbs.

*Shipping Weight*—8 lbs.

### Catalog Listing of “Two-Line” Monophones

#### Cat. AA-22 — Holding on both lines — Automatic

Equipped with three keys, one of which is used for switching from one line to the other; the other two keys are “holding” keys for lines Nos. 1 and 2, respectively. A call can be held on either line while the other line is being answered, but if a “holding” key is left operated when the handset is placed in the cradle, it will be automatically restored to normal. Instrument furnished complete with 11-conductor cord for connection to ringer box. Each telephone requires two ringer boxes (the ringer coils are used as holding bridges), even if the ringers are not required as signals.

#### Cat. AA-23 — Holding on both lines — Man., Conv.

As above, but with dial blank instead of dial.



## “Two-Line” Monophones

### Cat. AA-44 — Holding on both lines — Automatic

Designed primarily for use as an extension telephone, on lines where the above instruments are used at main stations, this telephone requires only a small auxiliary apparatus box containing an induction coil and a condenser. May be used also at main stations; requires then two ringer boxes, in addition to the auxiliary apparatus box. Instrument is equipped with two keys: a “line” key, which is used in switching from one line to the other; and a “hold” key, which, when operated, holds the connection on whichever line is not being used for conversation. If the hold key is not released, it automatically snaps back to normal when the handset is replaced in the cradle. Furnished complete with 9-conductor cord. Order auxiliary apparatus box separately—see below.

### Cat. AA-45 — Holding on both lines — Man., Conv.

As above, but with dial blank instead of dial.

### Cat. AA-24 — Holding on one line only — Automatic

Has only one key, through which the telephone is normally connected to line No. 1. When the key is depressed (with the handset off the cradle), the telephone is connected to line No. 2, and a holding bridge is placed on this line, so that a call on line No. 2 can be held while the key is switched back to line No. 1. No holding bridge is provided for line No. 1, so it is recommended that this type of “Two-Line” Monophone be used only where one line is a local or private line. Instrument is furnished complete with 9-conductor cord.

### Cat. AA-25 — Holding on one line only — Man., Conv.

As above, but with dial blank instead of dial.

### Cat. AA-26 — Switching only (no holding) — Automatic

Has only one key, for switching from one line to another, with no holding feature, and no connection between the key and the cradle switch. The switching key remains connected to whichever line was last used. Instrument furnished complete with 11-conductor cord.

### Cat. AA-27 — Switching only (no holding) — Man., Conv.

As above, but with dial blank instead of dial.

### Modifications

*Extensicord*, the “stretchable” handset cord (see page 40), can be supplied instead of the standard handset cord, if specified.

*Other number cards or plates* can be supplied. If desired, please give catalog numbers (see page 34).

“*Cutaway*” dial finger plate (see page 34) can be supplied instead of standard plate. If desired, please specify.

*Colored Monophones*—“Two-Line” Monophones are available also in Black, Walnut, Mahogany, Chinese Red, Old Ivory, Jade Green, Nile Green, Royal Blue, Orchid, or Maroon, with metal trim gold- or chromium-plated. These instruments are fitted with black Extensicord instead of standard handset cord, and desk stand cord has black braid covering. When ordering, specify color and trim desired.

### Ringer Boxes for “Two-Line” Monophones

Ringer boxes for use with “Two-Line” Monophones are of steel, identical in appearance with the metal ringer boxes shown on page 29. All boxes (except Cat. No. AO-27) are regularly equipped with polarized ringers, for straight-line, divided, or code ringing. If harmonic ringer is desired instead, give catalog number of corresponding ringer box having straight-line ringer, and state frequency desired.

*Dims.*—Height, 9 $\frac{5}{8}$ ”; width, 7 $\frac{1}{4}$ ”; depth, 4”.

*Net Weight*—5 lbs. *Shipping Weight*—7 lbs.

### Cat. AO-25 — For Monophones Nos. AA-22 or AA-23

For use on line No. 1, for either metallic or ground ringing.

### Cat. AO-26 — For Monophones Nos. AA-22 or AA-23

For use on line No. 2 (has distinctive gongs), for either metallic or ground ringing.

### Cat. AO-21 — For Monophones Nos. AA-44 or AA-45

For use on line No. 1, when these Monophones are used at main stations. For either metallic or ground ringing.

### Cat. AO-29 — For Monophones Nos. AA-44 or AA-45

For use on line No. 2 (has distinctive gongs), when these Monophones are used at main stations. For either metallic or ground ringing.

### Cat. AO-27 — For Monophones AA-24, -25, -26, or -27

Contains two single-gong straight-line ringers of different tones, and Monophone induction coil. For either metallic or ground ringing. (Or, can be supplied special with 2 a-c ringers and 1 3-volt d-c buzzer, or with 1 a-c ringer, and 1 6-12-volt d-c ringer, if specified).

### Cat. AO-28 — For Monophones AA-24, -25, -26, or -27

For use on line No. 1—either metallic or ground ringing.

### Cat. AO-29 — For Monophones AA-24, -25, -26, or -27

For use on line No. 2 (has distinctive gongs)—either metallic or ground ringing.

### Modifications

*Brass Base and Cover*, instead of steel, can be supplied on special order.

### Auxiliary Apparatus Box

Required with “Two-Line” Monophones Cat. Nos. AA-44 and AA-45. Identical in appearance with Type 32 Extension Boxes (see page 31).

### Cat. No. AO-67 — Auxiliary Apparatus Box

## The Type 34A3B Desk Monophone



Type 34A3B Monophone—Automatic  
Cat. Nos. AA-65 and AA-66

Because of its popularity with both the operating man and the telephone subscriber, many companies in recent years have standardized on the Type 34A3 Monophone for all installations where a self-contained desk-type instrument can be used. For such companies, we now offer a new instrument combining the basic design features of the Type 34A3 Monophone with the improvements provided in the new Type 41 Monophone handset. The base of the Type 34A3B Monophone is identical with that of the Type 34A3, except that the base molding is especially shaped to accommodate the Type 41 handset. Thus, the telephone company retains the advantages of standardization in circuit and in most of the major components; the use of the new handset results, however, in marked improvement in transmission quality and volume, and provides better comfort and "feel" in use.

The Type 41 Monophone handset is molded of black plastic, with receiver conductors molded in, and a large area in the cross-section of the handle for added strength. Transmitter and receiver are of the "capsule" type, inserted by merely slipping them into place, and readily removable without opening wire connections.

### Other New Features

The modernization of the Type 34A3 Monophone has been completed by the use of the new and exceptionally compact Type 11 and 12 Connecting Blocks used with the Type 40 Monophone, and black cords, instead of the brown cords formerly used. In most other respects, Type 34A3B is identical with the Type 34A3 Monophone. The circuit is the famous anti-side-tone circuit which has been standard in central-battery Monophones for many years. For operating organizations which have standardized on this circuit, and wish



Type 34A3B Monophone—Man., Conv.  
Cat. Nos. AA-67 and AA-68

to continue its use, the Type 34A3B Monophone will prove exceptionally satisfactory.

*Dimensions*—Height, 5½ in.; width of base, 5¾ in.; depth of base, 7¾ in. The handset is 9 in. long.

*Net Weight*—6½ lbs. *Shipping Weight*—13 lbs.

### Cat. No. AA-65—Type 34A3B—Auto.—Met. Rg.

With black plastic case, black-japanned dial finger plate, and chromium-plated transmitter and receiver bands. Type 24A36 dial has finger plate, number card and "1" to "0" number plate, as shown. Polarized untuned ringer with biasing spring, for straight-line or code ringing. Monophone handset with Monotype cord, 53 inches long. One condenser, and 2-conductor desk-stand cord, with 1-pair connecting block, for metallic ringing.

### Cat. No. AA-66—Type 34A3B—Auto.—Grd. Rg.

As above, but with 2 condensers, and 3-cond. desk-stand cord, with 2-pair connecting block, for ground ringing.

### Cat. No. AA-67—Type 34A3B—Man., Conv.—Met. Rg.

Like Cat. AA-65, above, but has black plastic dial blank, with number card and black-japanned card ring, as shown. All wiring for dial is provided (with impulse spring leads connected together), permitting conversion to automatic operation by merely adding the dial. One condenser, and 2-conductor desk-stand cord, with 1-pair connecting block, for metallic ringing.

### Cat. No. AA-68—Type 34A3B—Man., Conv.—Grd. Rg.

As above, but with 2 condensers, and 3-cond. desk-stand cord, with 2-pair connecting block, for ground ringing.

### Harmonic Ringing

The above catalog numbers cover Monophones with straight-line ringers. If harmonic ringer is desired, instead, give catalog number of corresponding instrument having straight-line ringer, and state frequency desired.

**For Modifications Available, see next page.**

## The Type 4A Extension Monophone



Type 4A Extension Monophone, complete with Dial and Bracket, for Automatic Service

A compact Monophone for extension service, and for use (with a ringer box or Monochime) as a main-line telephone to be mounted on the end of a desk. Requires a mounting space of only  $3\frac{3}{4}$ " x  $5\frac{1}{4}$ ", but in spite of its small size, all parts and connecting terminals are readily accessible when the molded plastic cover is slid off. The cover is removed by loosening the spanner nut of the Monophone switch (using tool AW-21, page 44).

For automatic service, the dial, with its connecting wires, is assembled on a mounting bracket, which may be mounted at either end of the wall box. The cover is drilled at both ends for the bracket, and a nicked plate is supplied to cover the mounting holes at the end not used. When the dial is not required, the holes at both ends are covered.

The Type 4A Monophone is wired in accordance with the anti-sidetone circuit used in the Type 1A Desk Monophone (see page 12).

### Modifications Available on Type 34A3B Monophones

*Extensicord*, the "stretchable" handset cord (see page 40), can be supplied instead of the standard handset cord, if specified.

*Other number cards or plates* can be supplied. If desired, please give catalog numbers (see page 34).

"*Cutaway*" dial finger plate (see page 34) can be supplied instead of round plate. If desired, please specify.

*Colored Monophones*—The Type 34A3B Monophone is available also in Black, Walnut, Mahogany, Chinese Red, Old

*Dimensions*—Height of wall box,  $3\frac{3}{4}$  in.; width,  $5\frac{1}{4}$  in. Depth, over all,  $4\frac{1}{2}$  in.; height,  $9\frac{1}{2}$  in.; width,  $8\frac{1}{2}$  in. The handset is 9 in. long.

*Net Weight*—5 lbs. *Shipping Weight*—8 lbs.

### Cat. No. AA-28—Extension Monophone—Automatic

With dial bracket and wires, and Type 24A36 dial with finger plate, number card, and "1" to "0" number plate, as shown.

### Cat. No. AA-29—Extension Monophone—Man., Conv.

Without dial, bracket and wires, and with dial mounting holes covered.

### Modifications

*Extensicord*, the "stretchable" handset cord (see page 40), can be supplied instead of the standard 53-inch handset cord, if specified.

*Other number cards or plates* can be supplied. If desired, please give catalog numbers (see page 34).

"*Cutaway*" dial finger plate (see page 34) can be supplied instead of round plate. If desired, please specify.

*For Main-Line Stations*, a special Type 4A Extension Monophone with buzzer signal can be furnished (metallic ringing only). This instrument is of the induction-coil-receiver type, requiring no induction coil in the wall box, and a 500-ohm a-c buzzer is installed in this space. If desired, specify "induction-coil-receiver" type.

### Mounting Bracket

An L-shaped mounting bracket, black japan finished, is available for mounting the Type 4A Monophone at right angles to an existing mounting surface. This bracket requires a mounting space of only  $2\frac{1}{2}$  in. x  $3\frac{3}{4}$  in.

### Cat. No. AW-10—Angle Mounting Bracket

Ivory, Jade Green, Nile Green, Royal Blue, Orchid, or Maroon, with gold- or chromium-plated trim. These instruments are fitted with black Extensicord instead of standard handset cord. When ordering, specify color and trim desired.

*Special transmitter*, providing exceptional transmission volume, can be supplied for use on extremely long lines. If desired, please specify.

*A Portable Telephone*—The Type 34A3B Self-Contained Desk Monophone is adapted for use as a portable telephone, using Portable Telephone Plug AZ-10, Jack AZ-11 (see page 42).

For Replacement Parts for the Type 34A3B Desk Monophone, see page 48.

## The Type 42 Wall Telephone



Type 42 Wall Telephone  
Cat. No. AB-24

The Type 42 Wall Telephone was designed to meet the needs of telephone men who prefer wall telephones of the "conventional" type with separate transmitter and receiver, and who wish to take advantage of the high transmission efficiency and balance provided in the newer Monophones. The principal components of the Type 42 Wall Telephone are identical and *interchangeable* with those used in Type 40 and Type 50 Monophones—a convenience which companies using these instruments will appreciate. And it employs the same perfectly balanced anti-sidetone circuit (see page 10) which gives these instruments their high transmission efficiency. The combination of the new "capsule" transmitter, "damped-diaphragm" receiver (also of the capsule type), and compact low-loss induction coil in the new circuit, improves transmission on circuits of high attenuation, without unpleasant volume or sidetone on circuits of low attenuation. The new circuit includes also a suppression network which is effective during dialing, to reduce radio interference.

The transmitter capsule is mounted in a molded plastic adapter which serves also as the transmitter mouthpiece. The receiver capsule fits into the receiver shell, and is held in place by the earcap. A Monotype cord, covered with brown braid, connects to the terminal strip within the wall box.

The ringer is mounted in rubber cushions and equipped with two-tone gongs which give a pleasing yet very penetrating signal. The two condensers used in the circuit provide for either metallic or ground ringing.



Type 42 Wall Telephone  
Cat. No. AB-25

*Dimensions*—Mounting space: height,  $9\frac{3}{4}$  in.; width, 7 in. Over-all height,  $9\frac{3}{4}$  in.; width, 10 in.; depth,  $7\frac{1}{2}$  in.

*Net Weight*—8 lbs. *Shipping Weight*—10 lbs.

### Cat. No. AB-24—Type 42 Wall Telephone—Automatic

Equipped with Type 24A36 dial, with finger plate, number card and "1" to "0" number plate as illustrated; polarized untuned ringer with biasing spring, for straight-line, divided, or code ringing. Wall box is of steel, finished in black japan. Dial finger stop is polished chromium plate, and cover locking screw is polished nickel plate. Receiver shell, and transmitter front, are black plastic.

### Cat. No. AB-25—Type 42 Wall Telephone—Man., Conv.

As above, but with black-japanned dial blank instead of dial. All wiring for dial is provided.

### Harmonic Ringing

The above catalog numbers cover telephones with straight-line ringers. If harmonic ringer is desired instead, give catalog number of corresponding instrument having straight-line ringer, and state frequency desired.

### Modifications

*Other number cards or plates*, can be supplied. If desired, give catalog numbers (see page 34).

*"Cutaway" dial finger plate* (see page 34) can be supplied instead of round plate. If desired, please specify.

*Brass Base and Cover*, instead of steel, can be supplied on special order.

### Conduit Adapter

An adapter is available for mounting the telephone on a standard 4-inch outlet box if the telephone wiring is to be run in conduit.

### Cat. No. AW-11—Outlet Mounting Adapter

For Replacement Parts for the Type 42 Wall Telephone, see page 49.

## The Type 21A Desk Telephone



Type 21A Desk Stand—Automatic  
Cat. No. AB-10

This "candlestick type" desk telephone is wired in accordance with the anti-sidetone circuit which has been used for many years in Automatic Electric telephones, but is equipped with the new "capsule type" transmitter and receiver, identical with those used in the latest Monophones. The use of these modern transmitters and receivers provides higher transmission volume and improved fidelity, as compared with the older Type 21 models.

The handsome appearance of the Type 21 telephone, with its offset transmitter post and the smooth lines of its transmitter hinge, has been further improved by the use of a new transmitter adapter of molded plastic, which serves also as the transmitter mouth-piece. This modern transmitter mounting combines handsome appearance with exceptional ruggedness.

Other features which have earned for Type 21 telephones their long popularity remain unchanged. The terminals molded into the base, and the mechanism of the dial, are all readily accessible by loosening the non-losable screw on the metal baseplate. The hook-switch is in the stem of the telephone, and is reached by simply removing another screw. A 6-foot Monotype cord is provided for connection to the ringer box.

All parts of the Type 21A desk stand (even to the transmitter and receiver assemblies) are completely interchangeable with present equipment, and the desk



Type 21A Desk Stand—Manual, Conv.  
Cat. No. AB-11

stand may be used with existing ringer boxes wired with the anti-sidetone circuit, and having 3-winding induction coils.

*Dimensions*—Height, 11½ inches; diameter of base, 5⅝ inches.

*Net Weight*—4 lbs. *Shipping Weight*—7 lbs.

### Cat. No. AB-10—Type 21A Desk Stand—Automatic

Equipped with Type 24A36 dial, with black-japanned finger plate, and number card and "1" to "0" number plate as illustrated. Base, transmitter front, and receiver shell and cap are molded black plastic; exposed metal parts heavily black-japanned (except dial finger stop, which is polished chromium plate); Monotype cords covered with brown braid. *Order ringer box separately* (Cat. Nos. AO-11, -12, -17, -18—see page 13.)

### Cat. No. AB-11—Type 21A Desk Stand—Manual, Conv.

As above, but dial and dial wiring are omitted, and a black plastic dial blank is provided instead. *Order ringer box separately* (Cat. Nos. AO-11, -12, -17, -18—see page 13.)

### Regular Booster Circuit

The Type 21A Desk Stand can also be supplied with regular booster circuit for use with ringer boxes containing a 2-winding induction coil. If desired, give catalog number of corresponding telephone, shown above, and specify "regular booster circuit". *Order ringer boxes separately.* (Cat. Nos. AO-13, -14, -19, -20—see page 29.)

### Modifications

*Other number cards or plates* can be supplied. If desired, please give catalog numbers (see page 34).

"Cutaway" dial finger plate (see page 34) can be supplied instead of round plate. If desired, please specify.

*Metal base*, instead of plastic, can be supplied on desk stand, when specified.

For Replacement Parts for the Type 21A Desk Stand, see page 50.

## The Type 21A Wall Telephone



Type 21A Wall Telephone  
Cat. No. AB-16

A sturdy, serviceable telephone, incorporating the anti-sidetone circuit (with 3-winding induction coil) which has been used for many years in Automatic Electric telephones, together with the new "capsule type" transmitter and receiver, as used in the latest Monophones, and in the Type 42 Wall Telephone. The use of these modern transmitters and receivers provides higher transmission volume and improved fidelity, as compared with the older Type 21 models.

The new transmitter provides lifelike transmission, and high volume output, from a carbon cell of low resistance, with consequent low carbon noise and long life. The transmitter capsule is mounted in a molded plastic adapter which serves also as the transmitter front and mouthpiece. The complete assembly fits into the shell in the conventional manner—four screws in the adapter fitting into bayonet slots in the transmitter shell.

The "capsule" receiver unit is of damped-diaphragm construction, providing high-fidelity reproduction of the voice, low apparent sidetone, and improved reception over circuits of high attenuation.

This receiver design also reduces the possibility of acoustic shock due to circuit transients. The receiver unit fits into the receiver shell, and is held in place by the earcap. A brown Monotype cord connects to the terminal strip within the wall box.

All parts of the Type 21A Wall Telephone (even to the transmitter and receiver assemblies) are completely interchangeable with those of the former Type 21 models.



Type 21A Wall Telephone  
Cat. No. AB-17

*Dimensions*—Mounting space: height,  $9\frac{3}{4}$ " ; width,  $7\frac{1}{4}$ ". Over-all height,  $9\frac{3}{4}$ " ; width, 10" ; depth,  $7\frac{1}{2}$ ".

*Net Weight*—8 lbs. *Shipping Weight*—10 lbs.

**Cat. No. AB-16—Type 21A Wall Telephone—Automatic**  
Equipped with polarized ringer, Type 24A36 dial with finger plate, number card, and "1" to "0" number plate, as shown. One condenser provided, for metallic ringing.

**Cat. No. AB-17—Type 21A Wall Tel.—Man., Conv.**  
As above, but dial, and dial wiring, are omitted, and black-japaned dial blank, as shown, is provided instead.

### Regular Booster Circuit

The Type 21A Wall Telephone can also be supplied with 2-winding induction coil, and wired in accordance with the regular booster circuit. If desired, give catalog number of corresponding telephone, as shown above, and specify "regular booster circuit".

### Harmonic Ringing

The above catalog numbers cover telephones with straight-line ringers. If harmonic ringer is desired instead, give catalog number of corresponding instrument having straight-line ringer, and state frequency desired.

### Modifications

*Additional condenser*, for ground ringing, can be supplied. If desired, please specify on order.

*Other number cards or plates* can be supplied. If desired, give catalog numbers (see page 34).

*"Cutaway" dial finger plate* (see page 34) can be supplied instead of round plate. If desired, please specify.

*Brass Base and Cover* instead of steel, can be supplied on special order.

### Conduit Adapter

An adapter is available for mounting the telephone on a standard 4-inch outlet box if the telephone wiring is to be run in conduit.

**Cat. No. AW-11—Outlet Mounting Adapter**

For Replacement Parts for the Type 21A Wall Telephone, see page 51.

## Outdoor Monophones

These sturdy instruments are especially adapted to severe conditions of use—particularly for outdoor service and for indoor locations exposed to moisture, humidity, or dust. All wiring is rubber-covered, and ringer and induction-coil windings are impregnated with waterproofing compound. Materials throughout are selected and finished to withstand extreme humidity. And, because of a unique arrangement of the ringer gongs and sound-hole openings, these telephones can be used even where there is danger of water being splashed up from below, as in boiler and engine rooms, dairies, refrigerating and ice-making plants, etc.

The Outdoor Monophone is enclosed in a case of cast aluminum alloy, with a cam-locking door closing tightly against a rubber gasket. A lock is provided, with two keys. Provision is made for molding into the cover the telephone company's name or other designation, at small additional cost.

The hookswitch for the Monophone handset, and (in the automatic models) the dial, are mounted on an inner panel. This panel is removed only for the installation or inspection of the telephone set, and is provided with a screw-eye so that during installation or inspection of the instrument it may be hung on a hook on the door, provided for that purpose.

The Monophone handset contains Automatic Electric Company's new "all-positions" transmitter, which operates with full efficiency in any position (or, for installation in very noisy locations, an especially designed "Anti-Noise" transmitter can be provided). A rubber-covered cord is provided, and a small coil spring takes up the slack in the cord, as it is released, and keeps it from being caught as the door is closed.

All connections are made through the terminal strip, and can be easily changed if required. Tapped conduit openings at both top and bottom of the case permit the use of  $\frac{1}{2}$ " conduit for the line wires. A wiring diagram is mounted on the back of the panel, showing connections both for manual and for automatic use.

These sets are equipped with 3-winding induction coils, and wired in accordance with the anti-sidetone circuit which has been used for many years in Automatic Electric telephones.

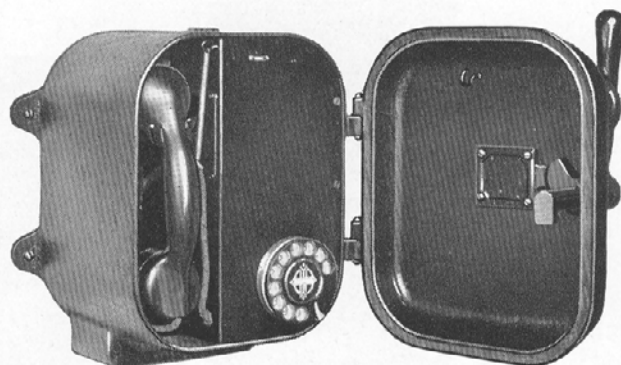

Outdoor Monophone Set  
Cat. Nos. AM-10 and AM-11

*Dimensions*—Height, 12"; width,  $8\frac{5}{8}$ "; depth,  $8\frac{1}{2}$ ".

*Net Weight*—23 lbs. *Shipping Weight*—43 lbs.

### Cat. No. AM-10—Outdoor Monophone—Automatic

Equipped with polarized untuned ringer with biasing spring, for straight-line or code ringing; Type 24A36 dial with finger plate, number card, and "1" to "0" number plate, as shown. One condenser provided, for metallic ringing. Case is handsomely finished in black "crackle" enamel, with inner panel and Monophone hook heavily black japanned. Black japan is standard finish on transmitter and receiver bands and dial finger plate (or dial blank), and is supplied unless otherwise ordered.

### Cat. No. AM-12—Outdoor Monophone—Man., Conv.

As above, but dial is omitted, and black-japanned dial blank is provided instead. All wiring for dial is provided (with impulse spring leads connected together), permitting conversion to automatic operation by merely adding the dial.

### Harmonic Ringing

The above catalog numbers cover instruments with straight-line ringers. If harmonic ringer is desired instead, give catalog number of corresponding instrument having straight-line ringer, and state frequency desired.

### Modifications

*Other number cards or plates* can be supplied. If desired, please give catalog number (see page 34).

*"Cutaway" dial finger plate* (see page 34) can be supplied instead of round plate. If desired, please specify.

*Additional condenser*, for ground ringing, can be supplied. If desired, please specify on order.

*"Anti-Noise" transmitter* is supplied, on special order.

## Flush Wall Telephones



Cat. Nos. AM-17 and AM-19

Cat. No. AM-21  
Flush Wall Telephones

Cat. No. AM-23

Telephones of this type are designed to be mounted over a steel outlet box set into the wall. They are used in hotels, theatres and other places where a distinctive wall instrument is desired, as well as in corridors, where the usual type of wall telephone might be subject to damage. Used also as elevator cab telephones.

Flush wall telephones are available in a number of styles, as listed below. Cat. Nos. AM-17 and AM-18 use a polarized receiver in a regular booster circuit. The other styles are wired in accordance with a "series" circuit, and are not recommended for use on long lines.

Instruments are completely wired, including dial wiring on manual convertible models. Transmitter is mounted flush with face of telephone, so that only the mouthpiece projects.

*Net Wt.*—3 lbs. *Shipping Wt.*—6 lbs. (approx.)

### Cat. No. AM-17—Booster Circuit—Automatic

Polarized untuned ringer with biasing spring, for straight-line or code ringing—one condenser, for metallic ringing only. Bevel-edged steel plate, 13 in. high, 7 $\frac{3}{8}$  in. wide, heavily black japanned, and perforated so that the ringer can be plainly heard. Supplied with standard outlet box, 12 in. high, 6 $\frac{3}{8}$  in. wide, 4 $\frac{1}{8}$  in. deep. Equipped with Type 24A36 dial, with finger plate, number card, and "1" to "0" number plate, as shown.

### Cat. No. AM-18—Booster Circuit—Manual, Conv.

As above, but with black-japanned dial blank instead of dial.

### Cat. No. AM-19—Series Circuit—Automatic

Identical, except for circuit, with Cat. No. AM-17 above. One condenser provides for either metallic or ground ringing.

### Cat. No. AM-20—Series Circuit—Manual, Conv.

As above, but with black-japanned dial blank instead of dial.

### Cat. No. AM-21—With A-C Buzzer—Automatic

Series circuit. Has watch-case receiver, and 500-ohm a-c buzzer signal, and is assembled on a bevel-edged plate of black plastic, with a dull-rubbed finish. This face plate acts as a resonator, so no sound-escape holes are necessary. Dimensions of plate: height, 10 $\frac{3}{4}$  in.; width, 7 $\frac{1}{8}$  in. Supplied with standard outlet box, 9 $\frac{3}{8}$  in. high, 5 $\frac{3}{4}$  in. wide, 1 $\frac{1}{2}$  in. deep. Equipped with Type 24A36 dial, with finger plate, number card, and "1" to "0" number plate, as shown. One condenser provides for either metallic or ground ringing.

### Cat. No. AM-22—With A-C Buzzer—Manual, Conv.

As above, but with black-japanned dial blank instead of dial.

### Cat. No. AM-23—Elev.-Cab. Model—Automatic

Identical with Cat. No. AM-21, above, but face plate is only 9 $\frac{3}{8}$  in. high and 5 $\frac{3}{4}$  in. wide, with rounded corners, and outlet box is not supplied.

### Cat. No. AM-24—Elev.-Cab. Model—Manual, Conv.

As above, but with black-japanned dial blank instead of dial.

### Harmonic Ringing

Cat. Nos. AM-17, -18, -19, and -20 cover telephones with straight-line ringers. If harmonic ringer is desired instead, give catalog number of corresponding instrument having straight-line ringer, and state frequency desired.

### Modifications

*Other number cards or plates* can be supplied. If desired, please give catalog numbers (see page 34).

"Cutaway" dial finger plate (see page 34) can be supplied instead of round plate. If desired, please specify.

*Additional condenser*, for ground ringing, can be furnished on Cat. Nos. AM-17 and -18, if specified on order.



## C. B. Telephones—Misc.

### The Mine-Type Telephone

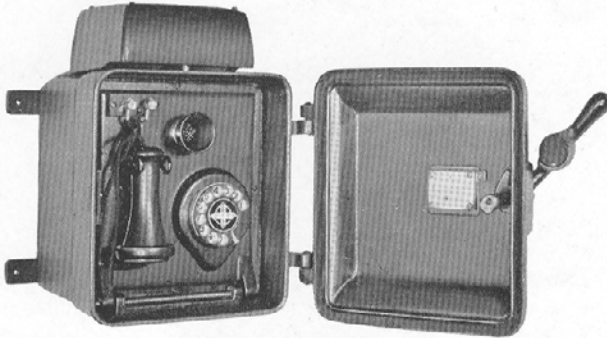

Mine-Type Telephone  
Cat. Nos. AM-27 and AM-28

The case of this telephone is of heavy cast iron, and has double doors, the outer door provided with a rubber gasket, and with a cam-type locking handle, for which two keys are supplied. The working parts of the telephone are mounted on the inner door, which is opened only for installation or inspection. The telephone line wires are brought in through either the top or the bottom, through  $\frac{1}{2}$ " tapped holes.

This telephone is equipped with a polarized ringer with 3" loud-ringing gongs, which is mounted under a cast-iron hood on top of the case. Connections to the ringer coils are made through insulated brass rods extending through bushings from the inside of the case.

The circuit used is the anti-sidetone circuit which has been used for many years in Automatic Electric telephones.

*Dims.*—Height, 15"; width, 11 $\frac{1}{2}$ "; depth, 12 $\frac{1}{2}$ ".

*Net Weight*—61 lbs. *Shipping Weight*—75 lbs.

#### Cat. No. AM-27—Mine-Type Telephone—Automatic

With Type 24A36 dial with finger plate, number card, and "1" to "0" number plate, as shown. One condenser provided, for metallic ringing. Case is finished, inside and out, with black rust-resisting paint. Receiver, and transmitter mouthpiece, are black plastic, dial finger plate and receiver hook heavily black japanned, dial finger stop polished chromium plate.

#### Cat. No. AM-29—Mine-Type Telephone—Manual, Conv.

As above, but dial is omitted, and black-japanned dial blank is provided instead.

#### Modifications

*Other number cards or plates* can be supplied. If desired, please give catalog numbers (see page 34).

*"Cutaway" dial finger plate* (see page 34) can be supplied instead of round plate. If desired, please specify.

*Additional condenser*, for ground ringing, can be supplied. If desired, please specify on order.

### The Bracket Monophone

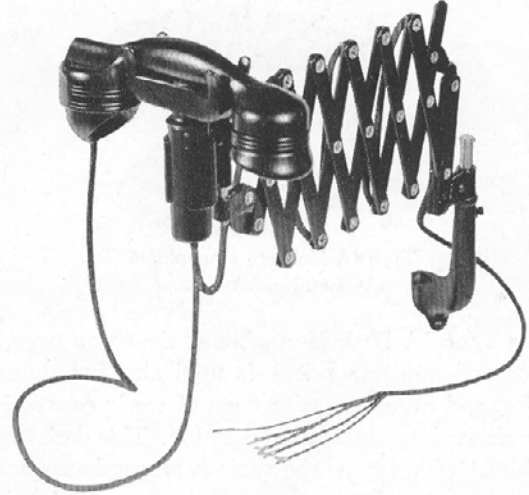

Bracket Monophone, Cat. No. AM-31

A Monophone handset with "all-positions" transmitter, on a black japanned cradle and bracket. Bracket may be turned on the base, and extends to a length of 28". Anti-sidetone circuit, for either central-battery or magneto service, requires ringer box with 3-winding induction coil.

*Net Weight*—7 lbs. *Shipping Weight*—10 lbs.

#### Cat. No. AM-31—Bracket Monophone

(Requires anti-sidetone ringer box—order separately)

### Special Equipment

For exceptional requirements which cannot be met by use of the foregoing standard instruments, various construction modifications and special fittings can be supplied, including:

Pushbuttons for auxiliary signaling circuits, or for connecting and disconnecting the transmitter, when desired.

Splashproof and dustproof dials (see page 33).

Luminous dial cards (see page 34).

Moistureproof wiring for locations of high humidity.

To order special instruments, add the word "Special" to the catalog number of the standard instrument, and state as fully as possible what changes are desired.

## Magneto Desk Monophones

### Type 1A



Type 1A Magneto Monophone  
Cat. No. AA-19

The Type 1A Desk Monophone (shown on page 12, for central-battery service) is used also for magneto service, and offers the advantage of ready conversion, when desired, to automatic operation. This desk stand, combined with any of the various ringer boxes available, will meet almost every requirement. It is wired in accordance with the Automatic Electric anti-sidetone circuit, which assures high-grade transmission.

*Dims.*—Height, 5 in.; diameter of base,  $5\frac{5}{8}$  in.  
*Net Weight*— $3\frac{1}{2}$  lbs. *Shipping Weight*—5 lbs.

#### Cat. No. AA-19—Type 1A Magneto Monophone

For use with magneto ringer box providing 3-winding induction coil. Order ringer box separately (Cat. Nos. AO-31, -32, -33, and -65—see page 30).

#### Cat. No. AA-43—Type 1A Monophone—“Tropical”

As above, but with rubber-insulated cords and wiring. Order ringer box separately (Cat. Nos. AO-31, -32, -33, and -65—see page 30).

NOTE: Monophone AA-43, with Ringer Box AO-65 (see page 30), meets U. S. Forestry Service Specification No. 4C, with approved modifications and improvements.

#### Modifications

*Extensicord*, the “stretchable” handset cord (see page 40), can be supplied instead of the standard cord, if specified.

*Pushbutton* can be provided, either to cut in the transmitter battery, to produce code-ringing signals, or to make the ringing semi-selective by putting the ringing current on one or the other side of the line. If desired, please specify.

*Metal Base and Cradle*—If desired, desk stand can be furnished with black-japanned brass base, and aluminum alloy cradle, instead of molded plastic.

*A Portable Telephone*—Because of its small size and light weight, the Type 1A Magneto Monophone is well adapted for use as a portable telephone. Use Portable Telephone Plug AZ-12, Jack AZ-13 (see page 42).

**For Replacement Parts for the Type 1A Monophone, see page 47.**

#### Type 40 Monophone for Magneto Service

The Type 40 Monophone (see pp. 8-9) can be supplied with L.B. induction coil, but no ringer, for use with a magneto ringer box (no induction coil required).

**Cat. No. AE-22—Type 40 Monophone (Magneto)**

### Type 8



Type 8 Magneto Monophone  
Cat. No. AE-10

A compact, self-contained desk telephone, for locations where it is not desired to have a separate ringer box; may be used, also, as a portable telephone, using the Telephone Plug and Jack shown on page 42. Contains a 3-winding induction coil, 2-bar generator, and 1000-ohm ringer, and is wired in accordance with the anti-sidetone circuit, which assures high-quality transmission. The Monophone handset is equipped with “all-positions” transmitter, and has Monotype cord, covered with brown braid.

The ringer and generator in this instrument are generally adequate on town lines where there are not more than four stations on the line. For long and heavily loaded lines, the use of telephones with 3- or 5-bar generators is recommended.

*Dimensions*—Height, 10 inches; width, 5 inches; depth, 6 inches. The handset is 9 inches long.

*Net Weight*—11 lbs. *Shipping Weight*—15 lbs.

#### Cat. No. AE-10—Type 8 Desk Monophone

Complete with 2-bar generator, 1000-ohm ringer, 3-winding induction coil, and Monophone handset. Equipped with Monotype desk stand cord, 6 feet long, covered with brown braid, and fitted with a small terminal block of molded plastic for connection to the line wires and the battery. Handset is molded black plastic; desk-set case, cradle, and transmitter and receiver bands are heavily black-japanned.

#### Modifications

*Extensicord*, the “stretchable” handset cord (see page 40), can be supplied instead of the standard handset cord, if specified.

*Condenser* can be provided if desired, wired in series with either the receiver, or the ringer, as specified.

## Magneto Wall Monophones

Type 10



Type 10 Magneto Wall Monophone  
Cat. No. AE-12

Magneto Wall Monophones combine the advantages of wall mounting with the convenience of the Monophone handset. They are out of the way, yet always at hand. May be mounted at any height, for use either while seated or standing.

The Type 10 Wall Monophone uses a steel wall box of the same type as that employed in our metal ringer boxes. The wall box contains a 2-bar generator and 1000-ohm ringer, which will be found adequate for town lines with not more than four parties on a line. Anti-sidetone circuit assures satisfactory transmission quality and volume.

*Dimensions:* Height, 12 in.; width, 9 in.; depth, 4 in., over all. The handset is 9 in. long.

*Net Weight*—11 lbs. *Shipping Weight*—15 lbs.

**Cat. No. AE-12—Type 10 Monophone**

With 1000-ohm ringer, 2-bar generator, 3-winding induction coil, and Monophone handset.

**Modifications**

*Extensicord*, the "stretchable" handset cord (see page 40), can be supplied instead of the standard handset cord, if specified.

*Condenser* can be provided if desired, wired in series with either the receiver or the ringer, as specified.

*Pushbutton* can be provided, either to cut in the transmitter battery, to produce code-ringing signals, or to make the ringing semi-selective by putting the ringing current on one or the other side of the line. If desired, please specify.

Type 18



Type 18 Magneto Wall Monophone  
Cat. Nos. AE-13 and AE-14

This instrument, also, combines Monophone convenience with "out-of-the-way" mounting, as offered by the Type 10 Monophone at left, but may be used on longer lines, with heavier loading. Anti-sidetone circuit, and "all-positions" transmitter in Monophone handset, assure high transmission efficiency.

*Dimensions*—Height, 12 $\frac{3}{4}$  in.; width, 9 in.; depth, 5 $\frac{1}{2}$  in., over all. The handset is 9 in. long.

*Net Weight*—15 lb. *Shipping Weight*—20 lbs.

**Cat. No. AE-13—Type 18 Monophone—1000-ohm Rgr.**

With 1000-ohm ringer, 3-bar generator, 3-winding induction coil, Monophone switch, and Monophone handset with "all-positions" transmitter, and 3-conductor Monophone cord, 53 inches long, covered with brown braid. Handset is lustrous black plastic, cabinet is beautiful rubbed golden oak, with exposed metal parts heavily black-japaned.

**Cat. No. AE-14—Type 18 Monophone—1600-ohm Rgr.**

Like above, but with 1600-ohm ringer, 5-bar generator.

**Modifications**

*Extensicord*, the "stretchable" handset cord (see page 40), can be supplied instead of the standard handset cord, if specified.

*Condenser* can be provided if desired, wired in series with either the receiver or the ringer, as specified.

*Pushbutton* can be provided, either to cut in the transmitter battery, to produce code-ringing signals, or to make the ringing semi-selective by putting the ringing current on one or the other side of the line. If desired, please specify.

## Magneto Wall Monophones

### Type 371B



Magneto Wall Monophone  
Cat. No. AE-16

A Wall Monophone for use on exceptionally long lines. Contains a special heavy-duty magneto and a sensitive 2500-ohm ringer with large (3") gongs, mounted on the outside of the case to assure a loud ringing signal. The magneto is only slightly larger than the standard 5-bar generator, but its output is about 50% greater, due to the use of a recently developed magnetic material.

This set is wired in accordance with a transmission circuit which provides exceptional voice efficiency. A condenser is provided, in the ringer and receiver circuits, to improve ringing, and simplify testing on the line. The case does not provide space for the battery, which can be placed in a battery box nearby.

*Dimensions*—Height, 10½ in.; width, 8½ in.; depth, 6¾ in.

*Net Weight*—15 lbs. *Shipping Weight*—20 lbs.

#### Cat. No. AE-16—Type 371B Monophone Wall Set

With 2500-ohm ringer and special 5-bar generator. Monophone handset has "all-positions" transmitter, and 3-conductor Monotype cord, 53 inches long, covered with brown braid. Handset is lustrous black plastic, cabinet is beautiful rubbed golden oak, with exposed metal parts heavily black-japanned.

NOTE—This instrument meets U. S. Forestry Service Specification No. 4A, with approved modifications and improvements.

#### Modifications

*Extensicord*, the "stretchable" handset cord (see page 40), can be supplied instead of the standard handset cord, if specified.

*Pushbutton* can be provided either to cut in the transmitter battery to produce code-ringing signals, or to make the ringing semi-selective by putting the ringing current on one or the other side of the line. If desired, please specify.

### Type 17 Extension

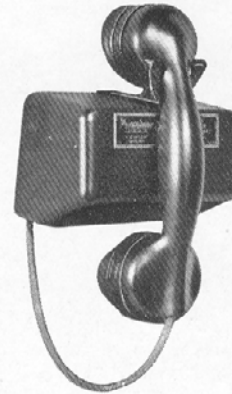

Magneto Extension  
Monophone  
Cat. No. AE-17

This Magneto Extension Monophone offers the magneto telephone user the convenience of an extension telephone, in a handsome and compact instrument which may be mounted nearly anywhere. It is designed for answering-extension service in locations where the ringer of the main-line station can be plainly heard; therefore, it does not contain a ringer or generator. It is also adapted to meet requirements for a main-line telephone to be mounted on the end of a desk, thus providing convenient telephone service without occupying desk space. For such applications, it can be used with any ringer box providing a generator and ringer. Anti-sidetone circuit assures high transmission quality.

*Dimensions*—Height of wall box, 3¾ in.; width, 5¼ in. Height, over all, 9 in.; width, 5¼ in.; depth, 4½ in.

*Net Weight*—4 lbs. *Shipping Weight*—6 lbs.

#### Cat. No. AE-17—Type 17 Extension Monophone

Equipped with 3-winding induction coil, Monophone switch, and Monophone handset with "all-positions" transmitter, and 3-conductor Monotype cord, 53 inches long, covered with brown braid. Wall box and Monophone handset are lustrous black plastic, with cradle and transmitter and receiver bands heavily black-japanned.

#### Modifications

*Extensicord*, the "stretchable" handset cord (see page 40), can be supplied instead of the standard handset cord, if specified.

#### Mounting Bracket

An L-shaped mounting bracket, black japan finished, is available for mounting set at right angles to an existing mounting surface. This bracket requires a mounting space of only 2½ in. by 3¾ in.

#### Cat. No. AW-10—Angle Mounting Bracket

## Magneto Telephones—Misc.

### Type 21A Desk Telephone



Type 21A Desk Stand  
Cat. No. AB-11

This "candlestick type" desk telephone may be used for either magneto or central-battery manual service, and is readily adapted, by merely adding the dial and its wiring, for central-battery automatic service. It is equipped with the new "capsule" type transmitter and receiver, identical with those used in the latest Monophones, and providing improved transmission volume and fidelity. The transmitter is mounted in an adapter of molded plastic, which serves also as the transmitter mouthpiece, thus combining handsome appearance with exceptional ruggedness.

The Type 21A Desk Stand is wired in accordance with the famous Automatic Electric anti-sidetone circuit, providing high-grade transmission on the longest line. Ringer boxes for use with this telephone are available to meet all requirements.

*Dimensions*—Height, 11½ inches; diameter of base, 5⅝ inches.

*Net Weight*—4 lbs.

*Shipping Weight*—7 lbs.

#### Cat. No. AB-11—Type 21A Desk Stand

With "capsule" type transmitter and receiver, black plastic dial blank, and 3-conductor Monotype desk stand cord, 6 feet long. Base, transmitter front, and receiver shell and cap are molded black plastic; Monotype cords covered with brown braid. *Order ringer box separately* (Cat. Nos. AO-31, -32, -33, and -65—see page 30).

**For Modifications Available, see at right.**

**For Replacement Parts for the Type 21A Desk Stand, see page 50.**

### Type 200 Wall Telephone



Type 200 Wall Telephone  
Cat. Nos. AG-11, AG-12 and AG-13

These instruments have been, for many years, the standard of large numbers of telephone companies operating magneto equipment. They are handsome in appearance and compact in design, and provide space for two No. 6 dry cells (*not furnished*).

*Dimensions*—Height, 15¼ in., width, 7¼ in., depth, 10¼ in., over all.

*Net Weight*—19 lbs. *Shipping Weight*—22 lbs.

#### Cat. No. AG-13—2500-ohm Ringer, 5-bar Generator

With 3-terminal induction coil, ringer with concealed gongs, generator, receiver and hookswitch, and local-battery transmitter.

#### Cat. No. AG-12—1600-ohm Ringer, 5-bar Generator

#### Cat. No. AG-11—1000-ohm Ringer, 3-bar Generator

#### Modifications

*Condenser* can be provided if desired, wired in series with either the receiver or the ringer, as specified.

*Pushbutton* can be provided, either to cut in the transmitter battery, to produce code-ringing signals, or to make the ringing semi-selective by putting the ringing current on one or the other side of the line. If desired, please specify.

**For Replacement Parts for the Type 200 Wall Telephone, see page 52.**

#### Modifications Available on Type 21A Desk Stand

*Brass base*, finished in black japan, can be furnished instead of molded plastic, if desired.

*Pushbutton* can be provided, either to cut in the transmitter battery, to produce code-ringing signals, or to make the ringing semi-selective by putting the ringing current on one or the other side of the line. If desired, please specify.

## Magneto Telephones—Misc.

### Special Wall Telephone

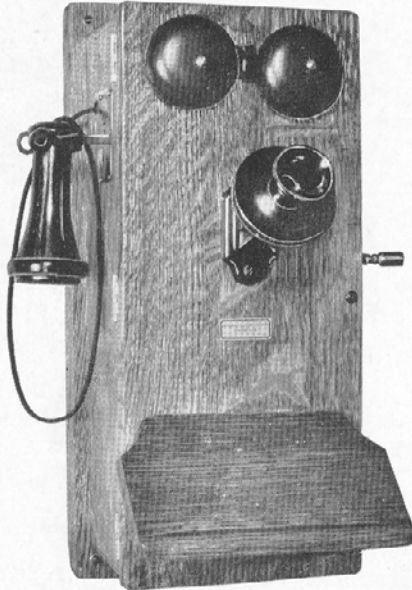

Type 200 Wall Telephone, Cat. No. AG-14

For long and heavily loaded lines. Has special 2500-ohm ringer, and space for three No. 6 dry cells.

*Dimensions*—Height, 20½ inches; width, 9¼ inches; depth, 10½ inches over all.

*Net Weight*—24 lbs. *Shipping Weight* 30 lbs.

**Cat. No. AG-14—Spl. Ringer, 5-bar Gen.**

NOTE—This instrument meets the requirements of the U. S. Forestry Service.

### Outdoor Monophone



Magneto Outdoor Monophone  
Cat. Nos. AM-14, AM-15 and AM-16

Adapted to the same severe conditions of use as the corresponding central-battery instrument (see page 21). This instrument employs a 3-volt dry-cell battery

of a new compact type, for transmission, and a standard magneto generator for signaling. Case is handsomely finished in black "crackle" enamel.

*Dims.*—Height, 12"; width, 8⅝"; depth, 8½".

*Net Weight*—28 lbs. *Shipping Weight*—48 lbs.

**Cat. No. AM-14—2500-ohm Ringer, 5-bar Gen.**

With 3-winding induction coil, ringer, magneto generator, hookswitch, and Monophone handset with "all-positions" transmitter and rubber-covered cord. *Order battery separately*—see below.

**Cat. No. AM-15—1600-ohm Ringer, 5-bar Gen.**

**Cat. No. AM-16—1000-ohm Ringer, 3-bar Gen.**

**Cat. No. S-2375—Compact Dry Battery—3-volt**

#### Modifications

"Anti-Noise" transmitter can be supplied on special order. If desired, please specify.

### Mine-Type Telephone

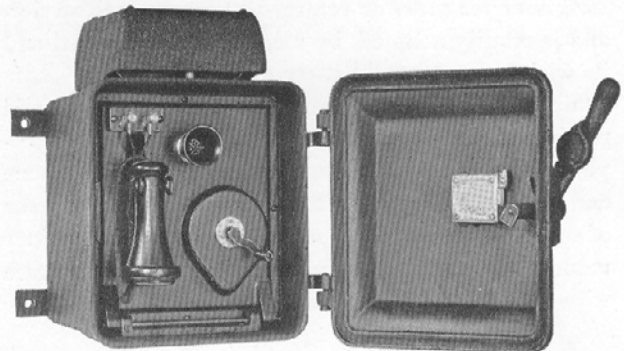

Magneto Mine-Type Telephone  
Cat. Nos. AM-32 and AM-33

This telephone is similar, in general design and rugged, moistureproof construction, to the central-battery Mine-Type Telephone, described on page 23, but is equipped and wired for local-battery operation.

*Dim.*—Height, 15"; width, 11½"; depth, 12¼".

*Net Weight*—70 lbs. *Shipping Weight*—85 lbs.

**Cat. No. AM-32—2500-ohm Ringer, 5-bar Gen.**

With 2-winding induction coil, ringer, magneto generator, hookswitch, transmitter, and receiver. Provides space for 2 No. 6 dry cells (*order separately*).

**Cat. No. AM-33—1600-ohm Ringer, 5-bar Gen.**

#### Modifications

*Condenser* can be provided if desired, wired in series with either the receiver or the ringer, as specified.

*Pushbutton* can be provided, either to cut in the transmitter battery, to produce code-ringing signals, or to make the ringing semi-selective by putting the ringing current on one or the other side of the line. If desired, please specify.

## Telephone Signals

### Type 32 C. B. Ringer Boxes

In these ringer boxes, all of the apparatus provided in older types of boxes has been placed in about half the space, *without sacrificing accessibility*. And the compact assembly has been cased in high grade molded plastic—strong, highly dielectric, and with a lustrous finish it will not lose. Telephone subscribers and telephone companies both like Type 32 Ringer Boxes because of their small size, pleasing appearance, and permanently handsome finish.



These boxes are available with equipment and wiring for use with almost all types and makes of central-battery telephones. Sound holes, in the bottom of the box, are lined with fine-mesh screen, to keep out insects.

*Dims.*—Height,  $7\frac{1}{4}$ " ; width,  $5\frac{1}{2}$ " ; depth,  $2\frac{5}{8}$ ".

*Net Weight*—4 lbs. *Shipping Weight*—7 lbs.

#### Cat. No. AO-11—Anti-Sidetone—Metallic Ringing

With polarized ringer for straight-line or code ringing, 3-winding induction coil, and one 1 mf. condenser. For metallic ringing with Type 1A Monophones and Type 21A telephones with anti-sidetone circuit.

#### Cat. No. AO-12—Anti-Sidetone—Ground Ringing

Like above, but with two condensers.

#### Cat. No. AO-13—Standard Booster—Metallic Ringing

With polarized ringer for straight-line or code ringing, 2-winding induction coil, and one 1 mf. condenser. For metallic ringing with Type 21A and other telephones with standard booster circuit.

#### Cat. No. AO-14—Standard Booster—Ground Ringing

Like above, but with two condensers.

#### Cat. No. AO-15—No Induction Coil—Metallic Ringing

With polarized ringer for straight-line or code ringing, and one 1 mf. condenser. For metallic ringing with Type 1A Monophones, Ind.-Coil-Rec. Ckt., and Type 4A Monophones (also with Types 4 and 7 Monophones).

#### Cat. No. AO-16—No Induction Coil—Ground Ringing

Like above, but with two condensers.

#### Harmonic Ringing

The above catalog numbers cover ringer boxes with straight-line ringers. If harmonic ringer is desired instead, give catalog number of corresponding ringer box having straight-line ringer, and state frequency desired.

### Metal C. B. Ringer Boxes

These ringer boxes are of conventional size and design, with base and cover of steel, finished in heavy black japan, and are available for use with almost any type or make of central-battery telephone. The cover locks with a single screw, which is accessible from the front of the box, thus making it possible to mount the ringer box in a corner or other out-of-the-way location.

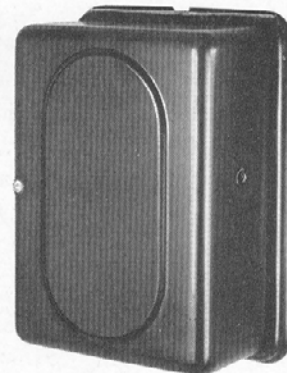

*Dimensions*—Height,  $9\frac{3}{4}$ " ; width,  $7\frac{1}{4}$ " ; depth, 4".

*Net Weight*—5 lbs. *Shipping Weight*—7 lbs.

#### Cat. No. AO-17—Anti-Sidetone—Metallic Ringing

With polarized ringer for straight-line or code ringing, 3-winding induction coil, and one 1 mf. condenser. For metallic ringing with Type 1A Monophones and Type 21A telephones with anti-sidetone circuit.

#### Cat. No. AO-18—Anti-Sidetone—Ground Ringing

Like above, but with two condensers.

#### Cat. No. AO-19—Standard Booster—Metallic Ringing

With polarized ringer for straight-line or code ringing, 2-winding induction coil, and one 1 mf. condenser. For metallic ringing with Type 21A and other telephones with standard booster circuit.

#### Cat. No. AO-20—Standard Booster—Ground Ringing

Like above, but with two condensers.

#### Cat. No. AO-21—No Induction Coil—Metallic Ringing

With polarized ringer for straight-line or code ringing, and one 1 mf. condenser. For metallic ringing with Type 1A Monophones, Ind.-Coil-Rec. Ckt., and Type 4A Monophones (also with Types 4 and 7 Monophones).

#### Cat. No. AO-22—No Induction Coil—Ground Ringing

Like above, but with two condensers.

#### Harmonic Ringing

The above catalog numbers cover ringer boxes with straight-line ringers. If harmonic ringer is desired instead, give catalog number of corresponding ringer box having straight-line ringer, and state frequency desired.

### Conduit Adapter

An adapter is available for mounting a metal ringer box on a standard 4-inch outlet box, if the telephone wiring is to be run in conduit.

#### Cat. No. AW-11—Outlet Mounting Adapter

For Ringer Boxes For Two-Line Monophones, see page 15.

## Telephone Signals

### The Monochime

A pleasant-sounding, "single-stroke" telephone gong which provides a new note in telephone signaling. Its soft, musical tone is subdued, but, because of its pleasing, measured stroke, can be heard for a considerable distance in a moderately quiet place.

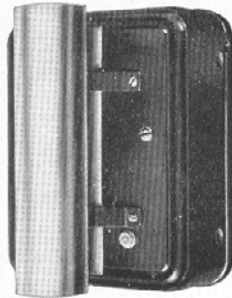

The Monochime operates directly from ringing current of standard 20-cycle frequency, requiring no relay or other wiring. May be used instead of the ordinary ringer box; or as a supplementary signal, by merely connecting it across the line. A condenser is provided in the ringing circuit to prevent the d-c talking current from flowing through the Monochime. The Monochime is available for both central battery and magneto stations, but should not be used for code-ringing or harmonic-ringing lines.

The Monochime is assembled in a case of lustrous black plastic, with the tone bar and resonator chamber, mounted on the cover, finished in highly polished chromium plate.

*Dimensions*—Height, 7 inches; width, 5¼ inches; depth, 5½ inches, over all.

*Net Weight*—4 lbs. *Shipping Weight*—6 lbs.

**Cat. No. AO-37—Anti-Sidetone—Metallic Ringing**

With 3-winding induction coil, one 1 mf. condenser, and Monochime signal. For metallic ringing with Type 1A Monophones, and Type 21A telephones with anti-sidetone circuit.

**Cat. No. AO-60—Anti-Sidetone—Ground Ringing**

Like above, but with two condensers.

**Cat. No. AO-61—Standard Booster—Metallic Ringing**

With 2-winding induction coil, one 1 mf. condenser, and Monochime signal. For metallic ringing with Type 21A and other telephones with standard booster circuit.

**Cat. No. AO-62—Standard Booster—Ground Ringing**

Like above, but with two condensers.

**Cat. No. AD-63—No Induction Coil—Metallic Ringing**

With one 1 mf. condenser, and Monochime signal. For metallic ringing with Type 1A Monophones, Ind.-Coil-Rec. Ckt.; also with self-contained instruments, and extension telephones containing an induction coil.

**Cat. No. OA-64—No Induction Coil—Ground Ringing**

Like above, but with two 1 mf. condensers.

### Magneto Ringer Boxes

These ringer boxes are assembled in golden oak cases, with exposed metal parts heavily black-japanned. Gongs are enclosed, and sound-holes in bottom of case are screened to keep out insects.



*Dims.*—Height, 9 $\frac{3}{16}$ " ; width, 7 $\frac{3}{4}$ " ; depth, 5 $\frac{1}{2}$ ".

*Net Weight*—14 lbs. *Shipping Weight*—18 lbs.

**Cat. No. AO-31—2500-ohm Ringer, 5-bar Gen.**

With 3-winding induction coil, 2500-ohm ringer, and 5-bar generator. For use with Types 1A and 17 Magneto Monophones, Type 21A magneto telephone, or Bracket Monophone, on long lines.

**Cat. No. AO-32—1600-ohm Ringer, 5-bar Gen.**

Like above, but with 1600-ohm ringer, for medium-loaded lines.

**Cat. No. AO-33—1000-ohm Ringer, 3-bar Gen.**

Like above, but with 1000-ohm ringer and 3-bar generator, for town and lightly loaded lines.

**Modifications**

*Condenser* can be provided, wired in series with either the receiver or the ringer, as specified.

*Pushbutton* can be provided, either to cut in the transmitter battery, to produce code-ringing signals, or to make the ringing semi-selective by putting the ringing current on one or the other side of the line. If desired, please specify.

### Magneto Ringer Box

For long and heavily loaded lines. Has extra-sensitive ringer, with 3-inch exposed gongs.

*Dims.*—Height, 10 $\frac{1}{2}$ " ; width, 8 $\frac{1}{2}$ " ; depth, 6 $\frac{3}{4}$ ".

*Net Weight*—16 lbs. *Shipping Weight*—22 lbs.

**Cat. No. AO-65—Special, for Long Lines**

With 3-winding induction coil, special 2500-ohm ringer, 5-bar generator, and condenser in receiver and ringer circuits. For use with Types 1A and 17 Magneto Monophones, Type 21A magneto telephone, or Bracket Monophone.

NOTE: Ringer Box AO-65, with Monophone AA-43 (see page 24), meets U. S. Forestry Service Specification No. 4C, with approved modifications and improvements.

**Modifications**

*Pushbutton* can be provided, either to cut in the transmitter battery, to produce code-ringing signals, or to make the ringing semi-selective by putting the ringing current on one or the other side of the line. If desired, please specify.



## Telephone Signals

### Type 32 C. B. Extension Boxes

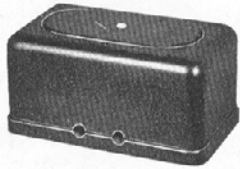

These small extension boxes provide all of the equipment contained in a ringer box, except the ringer. They are used with desk stands such as the Type 1A Monophone, when they are used as extension telephones and no bell is required, or at main-line telephones where a lamp or other special type of signaling equipment is provided. The compact case, only  $2\frac{1}{2}$  inches high, inches wide and  $5\frac{1}{8}$  inches long, is molded of high-grade black plastic.

**Cat. No. AP-10—Anti-Sidetone Circuit**

Contains 3-winding induction coil and 1 mf. condenser. For use with Type 1A Monophone, Type 21A Desk Telephone, or Bracket Monophone.

**Cat. No. AP-13—Anti-Sidetone Circuit—Signal Buzzer**

Like above, but with a 3-volt d-c buzzer, for use on a local signaling circuit—as, between the main and extension telephones.

**Cat. No. AP-12—Regular Booster Circuit**

Contains 2-winding induction coil and 1 mf. condenser. For use with Type 21A or other desk telephones with regular booster circuit.

**Cat. No. AP-15—Regular Booster Circuit—Signal Buzzer**

Like above, but with a 3-volt d-c buzzer, for use on a local signaling circuit—as, between the main and extension telephones.

### Magneto Extension Ringers

For use at answering extensions on magneto lines. Contain ringer and terminal strip only—no magneto or induction coil. Assembled in steel wall box, heavily black japanned. Dimensions: height,  $9\frac{3}{4}$ " ; width,  $7\frac{1}{4}$ " ; depth, 4".

*Net Weight*— $1\frac{1}{2}$  lbs.

*Shipping Wt.*—3 lbs.

**Cat. No. AO-39—Extension Ringer—2500-ohm**

**Cat. No. AO-40—Extension Ringer—1600-ohm**

**Cat. No. AO-41—Extension Ringer—1000-ohm**

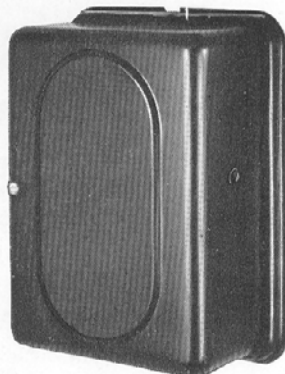

### Lamp Signals and Relays

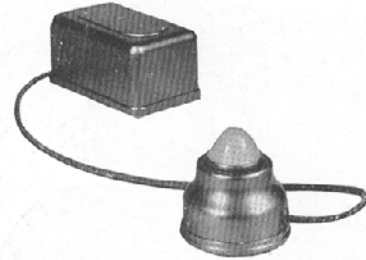

Use where quiet call signals are desired, or as busy visuals on lines having extension stations. Signal consists of a bronze-lacquered metal base,  $2\frac{3}{4}$  inches in diameter, and  $1\frac{1}{2}$  inches high, containing a lamp under a dome of colored glass, and equipped with 6-foot cord for connection to relay. Lamp operates from a battery or transformer on circuit controlled by the relay. Relay is cased in box of molded black plastic,  $2\frac{1}{2}$  inches high, 3 inches wide, and  $5\frac{1}{8}$  inches long.

**Cat. No. AS-78—Call Signal and Relay—48-volt**

Signal has 48-volt lamp, and red glass dome. Relay box contains condenser and a-c relay, which responds to regular straight-line or magneto ringing current, and closes the lamp circuit.

**Cat. No. AS-77—Call Signal and Relay—24-volt**

Like above, but with 24-volt lamp.

**Cat. No. AS-90—Busy Signal and Relay—48-volt**

Signal has 48-volt lamp, and red glass dome. Relay box contains d-c relay, which is to be connected in series with one side of the telephone line (central-battery only), operates when the handset is removed at any station on the line, and closes the lamp circuit.

**Cat. No. AS-91—Busy Signal and Relay—24-volt**

Like above, but with 24-volt lamp.

**Modifications**

*Twelve-volt lamp* can be supplied, on special order.

*White or green dome* can be supplied, if specified on order.

### Magneto Extension Ringer

Consists of 2500-ohm ringer and 0.7 mf. condenser in series. Height,  $5\frac{7}{8}$ " ; width,  $7\frac{1}{4}$ " ; depth,  $5\frac{3}{4}$ ". This ringer meets the requirements of the U. S. Forestry Service.

*Shipping Weight*—7 lbs.

**Cat. No. AO-66—Extension Ringer (Wood Box)**

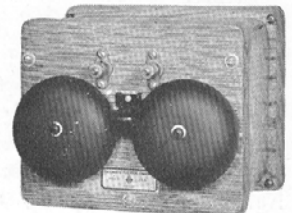

## Telephone Signals

### Loud-Ringing Bells

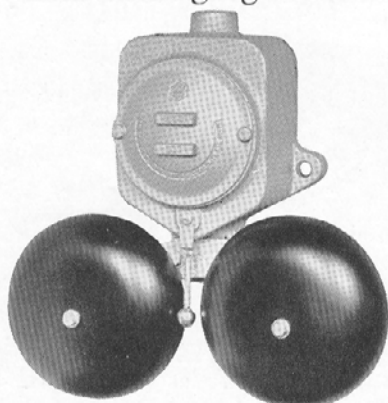

Weatherproof Loud-Ringing Bell  
Cat. No. AS-51

These bells, of the two-gong vibrating type, operate from straight-line ringing current, and may be simply bridged across the line. Supplied with condenser, for central-battery or magneto service, or without condenser, for magneto service only. They have 6" gongs, and powerful mechanism. Dimensions: width, 1'3"; height, 1'0".

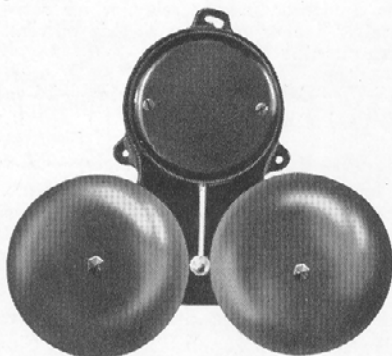

Splashproof Loud-Ringing Bell

**Cat. No. AS-51—Weatherproof Bell—C.B. or Mag.**

Recommended for service in exposed locations. 1600-ohm ringer mechanism and 2 mf. condenser, enclosed in a case of cast aluminum alloy, with 3/4-inch conduit connections at top and bottom.

**No. AS-52—Splashproof Bell—1600-ohm—C.B. or Mag.**

Can be used outdoors, if protected from direct exposure to the weather. Case is cast iron, finished in black japan. 1600-ohm ringer mechanism, 1 mf. condenser.

**Cat. No. AS-62—Splashproof Bell—1600-ohm—Mag.**

Like above, but has no condenser.

**Cat. No. AS-64—Splashproof Bell—1000-ohm—Mag.**

Like AS-52, but 1000-ohm ringer, no condenser.

**No. AS-65—Splashproof Bell—2500-ohm—C.B. or Mag.**

Like AS-52, but 2500-ohm ringer, 0.7 mf. condenser.

**Cat. No. AS-66—Splashproof Bell—2500-ohm—Mag.**

Like above, but has no condenser.

### Loud-Ringing Harmonic Bells

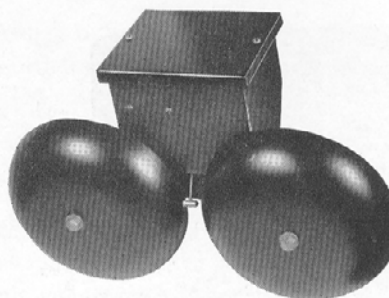

Loud-Ringing Harmonic Bell

Automatic Electric loud-ringing harmonic bells are equipped with 6-inch gongs, which are placed at an angle, so that when the bell is mounted, the sound from the back of the gongs is thrown back and up to the wall and ceiling, and thence reflected out into the space. The harmonic ringer movement, and a condenser, are mounted in a cast aluminum box, and box and gongs are finished in black japan. Bells can be furnished with regular ringer coils and wiring, for indoor use, or with impregnated coils and rubber-covered wiring, for outdoor installation.

*Dimensions* — Height, 8 $\frac{3}{4}$  inches; width, 12 $\frac{3}{4}$  inches; overall depth, 4 $\frac{1}{2}$  inches.

Freq., Cycles	Condenser Capacitance	Catalog Numbers	
		Indoor	Outdoor
16.6	0.7 mf.	AO-42	AO-51
25	0.7 mf.	AO-44	AO-53
33.3	0.4 mf.	AO-46	AO-55
50	0.4 mf.	AO-48	AO-57
66.6	0.4 mf.	AO-50	AO-59
20	0.7 mf.	AO-43	AO-52
30	0.7 mf.	AO-45	AO-54
42	0.4 mf.	AO-47	AO-56
54	0.4 mf.	AO-49	AO-58
66	0.4 mf.	AO-50	AO-59

### Continuous Telephone Signaling Unit

Consists of an A.C. relay which operates on straight line central-battery or magneto ringing current, and closes a local circuit to a signal which then operates continuously until the relay is released by pushing a button in the bottom of the case. Relay contacts will carry 5 amperes at 110 V., A.C., and the unit can be used with any type of signal. A 2 mf. condenser is included, for use on central-battery lines.

**Cat. No. AP-18—In Case for Indoor Installation**

**Cat. No. AP-19—In Case for Outdoor Installation**

## Telephone Parts

### The Type 24A36 Dial

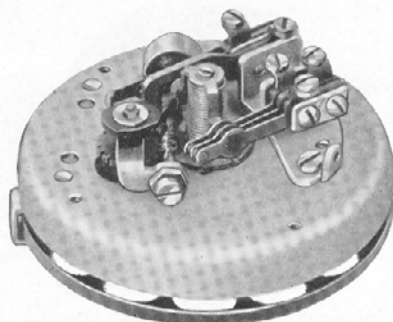

Rear View of Type 24A36 Dial  
Cat. No. AK-11

Once you operate an Automatic Electric dial, you know why this dial is famous, throughout the world, for its dependability and its phenomenally long life. Its smooth, quiet action—without vibration and without noise—tells you at once that this dial will give you long and satisfactory service.

The smooth operation of the Type 24A36 dial results from features of design and construction based on more than forty years of making dials. Each feature has been service-tested for its purpose—the double-lobed impulse cam of phenol fibre for smooth and uniform pulsing; the lightweight worm-driven governor to keep pulsing speed constantly within close limits; the helical driving spring for longest life and greatest ease of adjustment; the lightweight finger plate to reduce the “flywheel” effect when stopping—and all these features are combined in the Type 24A36 dial.

The working parts of the dial are assembled as a unit, on which the spring assembly, number plate, finger plate, and number card are mounted. Spring assemblies include the impulse springs and a set of shunt springs which remove the transmitter and receiver from the circuit during dial operation, to improve pulsing and prevent clicking in the receiver. A number of shunt spring arrangements are available, to fit various circuit conditions.

Pulsing speed of Automatic Electric dials is accurately adjusted at the factory, and is normally maintained through a long service life, with little further adjustment. Adjustments, when required, are easily made, as the driving spring, the governor, and the

impulse and shunt springs are all on the back of the dial—readily accessible without removing the dial from the telephone.

Number cards, finger plates and number plates are offered in various designs, as shown on page 34, and can be changed if desired. A unique locking device, concealed under the number card, prevents tampering with these parts.

Dials listed below may be used in any of the instruments shown in this catalog.

#### Cat. No. AK-11—Standard Dial—Black Finger Plate

Equipped with Spring Assembly AK-25, providing three shunt springs (which place separate shunts around the transmitter and the receiver during dialing). Has “1” to “0” number plate, and round finger plate with Number Card AK-35 (as shown on all instruments in this catalog).

#### Cat. No. AK-56—Standard Dial—Chromium-Plated

Like above, but with chromium-plated finger plate and escutcheon ring.

#### Cat. No. AK-22—“Splashproof” Dial—Black

For use in instruments exposed to excessive moisture (or dust). Has spring assembly as described above, “1” to “0” number plate molded of black plastic with engraved numerals filled with white enamel, and round finger plate with metal number card finished in black, with “1” to “0” designations in luminous paint, to permit dialing in poor light.

#### Cat. No. AK-47—“Radio-Suppressor” Dial—Black

Used to prevent the “broadcasting” of dial impulses to a radio receiving set, which may otherwise occur when an aerial is located near an open-wire telephone line. Like Cat. No. AK-11, above, but is equipped also with a 0.1 mf. condenser, and a 2-winding radio-frequency choke coil, mounted in the dial cup and wired to the springs.

#### Cat. No. AK-62—“Radio-Suppressor” Dial—Chrome

Like above, but with chromium-plated finger plate and escutcheon ring.

#### Modifications

*Other shunt spring arrangements* are available (see page 34). If desired, specify catalog number of spring assembly.

*Other number cards or plates* can be supplied. If desired, please give catalog numbers (see page 34).

*“Cutaway dial finger plate* (see page 34) can be supplied instead of round plate. If desired, please specify.

*Gold Dials*—above dials can be supplied with gold-plate finish, if specified.

**For Replacement Parts for Type 24A36 Dials, see pages 34 and 54.**

# Telephone Parts

## Dial Spring Assemblies

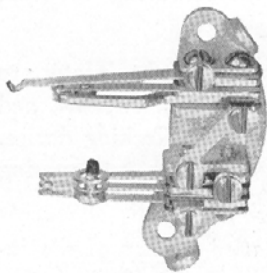

Each spring assembly consists of a pair of impulse springs and a set of shunt springs, assembled on a bracket which mounts, with two screws, on the rear of the dial. Spring assembly AK-25 is used on all of the telephones listed in this

catalog. Other assemblies shown provide other arrangements of shunt springs, as required for various circuits.

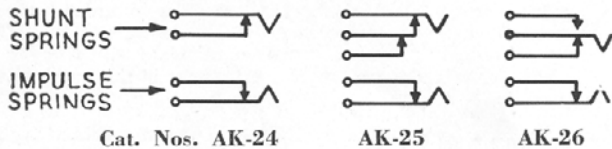

Cat. Nos. AK-24

AK-25

AK-26

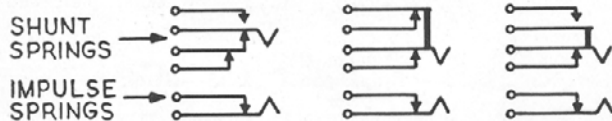

Cat. Nos. AK-27

AK-28

AK-29

Dial Spring Assemblies

(Shunt springs shown in off-normal position)

## Dial Number Plates

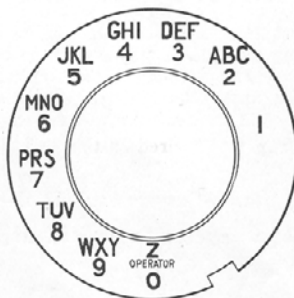

Dial Number Plate  
Cat. No. AK-32

Plate AK-30 is regularly provided on all of the automatic telephones shown in this catalog. If either of the other styles shown is desired, please specify when ordering telephone.

Cat. No. AK-30—Numbered "1" to "0" in black

Cat. No. AK-31—"1" to "0", and Operator"

With "operator" added in "0" space. Letters and figures in black.

Cat. No. AK-32—Number Plate, as illustrated above.

Black letters and red figures.

## Dial Finger Plates



Dial with "Cutaway" Finger Plate

Beside the regular round plate, shown on all of the automatic telephones in this catalog, a special "cutaway" plate is also available.

It differs from the round plate in that a portion of the plate is cut away, and the underside of the finger plate is finished in white enamel. In this way, a greater amount of light is admitted to the dial number plate. The cutaway portion of the finger plate also makes it easier to keep the number plate perfectly clean.

If telephone is desired with "cutaway" plate, please specify when ordering telephone.

Cat. No. AK-33—Round Plate—Black-Japanned

Cat. No. AK-58—Round Plate—Chromium-Plated

Cat. No. AK-59—Round Plate—Gold-Plated

Cat. No. AK-34—"Cutaway" Plate—Black-Japanned

Cat. No. AK-60—"Cutaway" Plate—Chromium-Plated

## Number Cards and Cover



Cat. No. AK-36

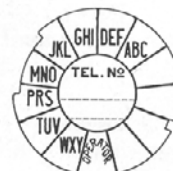

Cat. No. AK-37  
Number Cards



Cat. No. AK-38

Number card AK-35 is regularly supplied on automatic telephones shown in this catalog. Other cards shown are provided if specified. Cat. No. AK-38 is black-finished brass, with luminous markings, for use on telephones in poorly-lighted locations.

Number cards are protected by a clear celluloid cover, die cut to fit the escutcheon ring.

Cat. No. AK-35—Number Card, for Tel. No. only

Cat. No. AK-36—Number Card, with "Long Distance"

Cat. No. AK-37—Number Card, as shown

Cat. No. AK-38—Number Card—Luminous

Cat. No. AK-39—Celluloid Cover for Number Card

## Telephone Parts

### "Radio Suppressor" for Dials

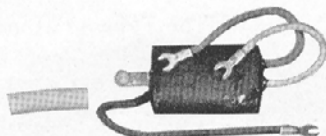

Dial "Radio Suppressor"  
Cat. No. AK-48

This unit can be connected to any dial, and serves the same purpose as the "Radio Suppressor" dial. It is only  $1\frac{1}{4}$ " x  $\frac{3}{4}$ " x  $\frac{5}{16}$ " in size, and mounts within the telephone, three cords and a screw terminal being provided for connection to the dial.

Cat. No. AK-48—"Radio Suppressor" for Dials

### Dial Blanks

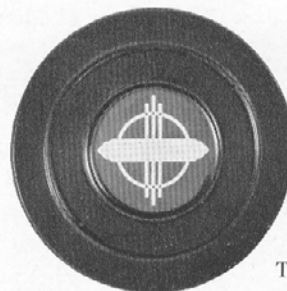

Typical Dial Blank

Dial blanks shown on manual convertible telephones in this catalog are furnished complete with number card and celluloid cover, and with necessary mounting parts.

Cat. No. AK-55—Dial Blank—Black Plastic  
For Type 40 Monophone

Cat. No. AK-57—Dial Blank—Black Plastic  
For Type 50 Monophone

Cat. No. AK-17—Dial Blank—Black Plastic  
For Type 34A3B, Type 1A, or "Two-Line" Monophones, or Type 21A Desk Telephone.

Cat. No. AK-63—Dial Blank—Black-Japanned  
For Type 42 Wall Telephone.

Cat. No. AK-20—Dial Blank—Black-Japanned  
For Type 21A Wall Telephone, Outdoor Monophone Set, or Mine-Type Telephone.

Cat. No. AK-21—Number Card for Dial Blank

Cat. No. AK-52—Celluloid Cover for Number Card

#### Modifications

*Colors*—Cat. Nos. AK-55, AK-57, and AK-17 can be furnished in colors, and with gold- or chromium-plated escutcheon ring. If desired, please give catalog number of corresponding black dial blank, as shown above, and state desired color and trim.

### Offset Base for W. E. Desk Stands

Used where manual desk stands of Western Electric Co. manufacture are to be converted to dial operation. A telephone so converted is generally similar in appearance to the Type 21A desk stand (see page 19).

The offset base is molded of black plastic, and has eight terminals molded in, and fitted with terminal screws. It is clamped to the post of the desk stand by means of a large spanner nut, which is furnished. Base is furnished without dial, which should be ordered separately (see page 33).

Cat. No. AK-53—Offset Base

Cat. No. AK-54—Spanner Wrench

For spanner nut used on offset base.

### Dial Mounting Cups

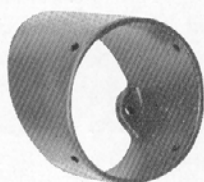

Cat. No. AK-16

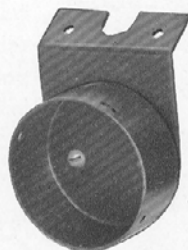

Cat. No. AK-49

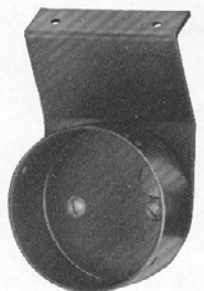

Cat. No. AK-50

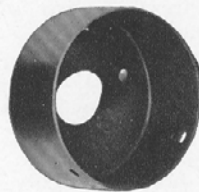

Cat. No. AK-51

Dial Mounting Cups

When manual lines are converted to automatic operation, the advantages of automatic operation can be obtained by mounting dials on the present wall and desk telephones (provided they are in good condition).

Cups for this purpose are listed below. They are of steel, finished in black japan, and mount with two wood screws or machine screws (not furnished). Cups are furnished complete with screws for mounting dial.

Cat. No. AK-16—Mounts dial on face of wall set

Cat. No. AK-49—Mounts dial below box of wall set

Cat. No. AK-50—Like above, but for wall sets on which only the front of the box opens

Cat. No. AK-51—Mounts on base of desk telephone

## Telephone Parts

### Type 41 Handset



Type 41 Handset  
(Furnished Complete  
with Cord).

The Type 41 Monophone Handset is used in Types 40, 50, and 34A3B Monophones, shown in this catalog. It is modern in appearance, light in weight and well-balanced for easy use, and is equipped with the newest type of "capsule" transmitter and receiver, providing high transmission volume and fidelity over the entire range of ordinary operating conditions. The handset is molded of plastic, with receiver wires molded directly into the handle.

The "regular" Type 41 Handset is equipped with a cord of standard Monotype construction, providing insulation which is even better than that generally known as "moistureproof". This handset will meet all but the most severe climatic conditions. However, for use in locations of high humidity, a "tropical" handset, with rubber-insulated cord, is listed below.

*Net Weight—17 oz. Shipping Weight—1½ lbs.*

**Cat. No. AF-48—"Regular"—For Types 40 and 50**

Has "regular" transmitter and mouthpiece, and three-conductor Monotype cord, 53 inches long, covered with durable black braid. Transmitter and receiver bands finished in polished chromium plate.

**Cat. No. AF-51—"Tropical"—For Types 40 and 50**

Like above, but with special rubber-insulated cord.

**Cat. No. AF-55—"Regular"—For Type 34A3B**

Like AF-48, above, but with cupped mouthpiece.

**IMPORTANT NOTE:** The Type 41 handset should not be used to replace handsets on Type 34A3 Monophones (the base molding of the Type 34A3B Monophone is especially shaped to accommodate this handset.)

#### Modifications

*Extensicord*, the "stretchable" handset cord (see page 40), can be supplied instead of the standard handset cord, if specified.

*Colored Handsets*—Type 41 Handsets can be furnished in Black, with transmitter and receiver bands finished in satin gold plate; also, in Walnut, Mahogany, Chinese Red, Old Ivory, Jade Green, Nile Green, Royal Blue, Orchid or Maroon, with metal bands gold- or chromium-plated. These handsets are fitted with black Extensicord (see page 40), instead of standard handset cord. When ordering, specify color and trim.

### Type 38 Handset

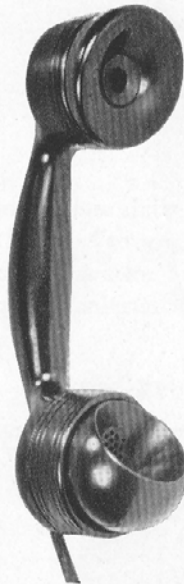

Type 38 Handset  
(Furnished Complete  
with Cord)

The Type 38 Monophone Handset is used in Types 1A, 4A, 8, 10, 18, and 371B Monophones, in "Two-Line" and Bracket Monophones, and in Outdoor Monophone sets, all shown in this catalog. It is also offered for replacement purposes on Types 34A3 and 35A5, and all earlier types of Monophones.

This handset is molded of plastic with transmitter and receiver caps of the same material, held in place by metal bands. It is equipped with a polarized receiver and an "all-positions" transmitter, and can be used at any point, on lines of almost any length, for either central-battery or local-battery service.

*Net Weight—20 oz. Shipping Weight—2 lbs.*

**Cat. No. AF-10—Type 38 Handset—"Regular"**

With 3-conductor Monotype cord, 53 inches long, covered with durable brown braid. Handset is black plastic, transmitter and receiver bands heavily black-japanned.

**Cat. No. AF-14—Type 38 Handset—"Tropical"**

Like above, but with special rubber-insulated interior wiring and handset cord, for use outdoors, in tropical climates, etc.

**Cat. No. AF-12—Type 38 Handset—"Anti-Noise"**

For use in noisy locations, such as shops, engine rooms, trading floors, etc. Contains a special transmitter and special mouthpiece, which combine to effectively cut off all sounds not spoken directly into the transmitter. Has 3-conductor Monotype cord, 53 inches long, covered with durable brown braid. Handset is black plastic, transmitter and receiver bands heavily black-japanned.

#### Modifications

*Extensicord*, the "stretchable" handset cord (see page 40), can be supplied instead of the standard handset cord, if specified.

*Induction-Coil Receiver*—Type 38 Handsets can be supplied with induction-coil-type receiver, for use in central-battery Monophones employing this type of circuit.

*Colored Handsets*—Handsets AF-10 and AF-14 can be furnished in colored plastics, described at left.

For Replacement Parts for Monophone Handsets, see page 55

## Telephone Parts

### The Type 42 Transmitter

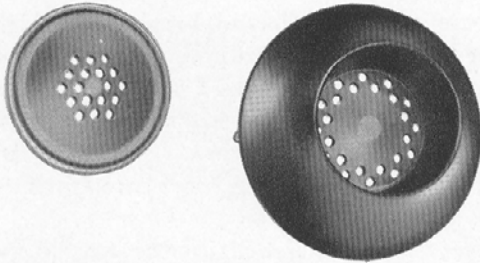

This is the same capsule-type transmitter unit used in the latest Monophones, assembled into an adapter which will mount in almost any conventional telephone. It may be used for central-battery or local-battery service, and will provide higher transmission volume and improved fidelity as compared with older designs. Telephone companies operating Type 40, Type 50, or Type 34A3B Monophones will appreciate also the advantages of using the same transmitter capsule on both handset and conventional telephones.

The adapter used with this transmitter is molded of black plastic, and serves also as the transmitter mouthpiece, so that a separate mouthpiece is not required. The complete assembly fits into the transmitter shell in the conventional manner, with four equally spaced mounting screws (which are furnished).

The Type 42 Transmitter is standard equipment in the Type 42 Wall Telephone, and in Type 21A Desk and Wall Telephones. It can also be used for replacement purposes in Type 21 and Type 200 Desk and Wall Telephones, and in telephones of the following makes: Monarch, Kellogg, Western Electric, and Dean.

**Cat. No. AF-50—Type 42 Transmitter, complete**

**Cat. No. AF-53—Transmitter Capsule, only**

### The Type 6 Transmitter

Used in Type 200 Wall Telephones, and in Flush Wall Telephones and Mine Telephones (both central-battery and local-battery types). Can also be used for replacement purposes in Type 21 and other telephones, as listed under the Type 42 transmitter, above. Transmitter fronts are black-japanned, and have four equally spaced tapped holes for mounting. *If mounting screws are desired, please specify.*

**Cat. No. AF-20—Type 6 Transmitter—C.B.**

**Cat. No. AF-21—Type 6 Transmitter—L.B.**

**Cat. No. AF-22—L.B. Transmitter, with Mounting Arm**  
For Type 200 Wall Telephone.

**Cat. No. AF-23—Transmitter Mouthpiece**

### The Type 42 Receiver



Consists of a capsule-type receiver unit, identical with that used in the newest Monophones, in a conventional receiver shell of molded black plastic, with an earcap of the same material. The receiver unit is of "damped" construction, and has negligible variation over the entire range of frequencies between 300 and 3000 cycles. This accurate response provides high-fidelity reproduction of the voice, and low apparent sidetone, besides improving reception over high-attenuation circuits (in which the response through previous types of receivers is sharply reduced at high frequencies).

The Type 42 Receiver is standard equipment in the Type 42 Wall Telephone, and in Type 21A Desk and Wall Telephones. It can be used for replacement purposes in almost all conventional types of telephones.

**Cat. No. AF-52—Type 42 Receiver, complete**

With brown Monotype cord, 33 inches long.

**Cat. No. AF-54—Receiver Capsule, only**

#### Modifications

*Rubber-Insulated Cord* can be supplied on the Type 42 receiver, if specified, for use in outdoor telephones, etc. (The receiver capsule is not affected by atmospheric conditions.)

### The Type 23 Receiver

Supplied with Type 200 Wall Telephones, and with Flush Wall Telephones and Mine Telephones (both central-battery and local-battery types). Can be used with almost all conventional types of telephones. Receiver shell and cap are molded of black plastic.

**Cat. No. AF-31—Polarized Receiver**

With brown Monotype cord, 33 inches long.

#### Modifications

*Rubber-Insulated Cord* can be supplied on the Type 23 receiver, if specified, for use in outdoor telephones, etc.

# Telephone Parts

## C. B. Ringer Movements



Straight-Line Ringer Movement  
Cat. No. AS-80

These ringer movements may be used on all Automatic Electric ringers, either for replacement purposes, or for the purpose of converting from straight-line to harmonic ringing, or from one harmonic frequency to another, or from harmonic to straight-line ringing, as desired. Complete movement consists of armature mounting with armature and clapper, and two ringer coils, covered with empire cloth. Coils are assembled on an iron yoke (not shown in illustration), which is removed when movement is to be installed. The movement may be readily mounted with two screws, and screw terminals are provided on the ringer coils, so the connections can be made without soldering. Each movement is plainly labeled to show frequency, condenser capacitance to be used, etc.

Movements listed below are recommended for use on lines having not more than five metallic-ringing, or ten ground-ringing, stations. For lines with heavier loading, see "High-Impedance Ringers", at right.

- Cat. No. AS-80—Straight-Line Ringer Movement
- Cat. No. AS-81—Harmonic Movement (16.6-cycle)
- Cat. No. AS-83—Harmonic Movement (25-cycle)
- Cat. No. AS-85—Harmonic Movement (33.3-cycle)
- Cat. No. AS-87—Harmonic Movement (50-cycle)
- Cat. No. AS-89—Harmonic Movement (66.6-cycle)
- Cat. No. AS-82—Harmonic Movement (20-cycle)
- Cat. No. AS-84—Harmonic Movement (30-cycle)
- Cat. No. AS-86—Harmonic Movement (42-cycle)
- Cat. No. AS-88—Harmonic Movement (54-cycle)
- Cat. No. AS-89—Harmonic Movement (66-cycle)

For Ringer Parts—coils, armatures, etc.—see pages 56 and 57.

For completely assembled straight-line ringers, and associated parts—gongs, mounting screws, etc—see Telephone Parts lists, as follows:

- Type 40 Monophone—page 45
- Type 50 Monophone—page 46
- Type 34A3B Monophone—page 48
- Type 42 Wall Telephone—page 49
- Type 21A Wall Telephone—page 51
- Ringer Boxes—page 53

For harmonic ringers, and for parts for other Automatic Electric telephones, give description of parts, and catalog number or other description of telephone or ringer box in which they are to be installed.

**For Replacement Parts for Central-Battery and Local-Battery Ringers, see pages 56 and 57.**

## High-Impedance Ringers

For use on heavily loaded lines, special high-impedance ringers can be furnished. These ringers are interchangeable with standard ringers but require special condensers of low capacitance. Telephones and ringer boxes using these ringers therefore require separate ringing and talking condensers (for metallic as well as ground ringing).

When ordering a high-impedance ringer, specify type of telephone in which it is to be used. Ringing condenser of proper capacitance is furnished with each ringer. If mounting parts (screws, washers, etc.) are desired, please specify.

Any central-battery telephone or ringer box listed in this catalog can be furnished with high-impedance ringer and proper ringing condenser, if desired. When ordering, give catalog number, description, and all other information required for standard instrument and then specify "With high-impedance ringer".

## Local-Battery Ringers

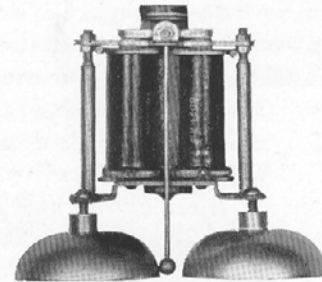

Supplied with gongs, unless otherwise specified.

- Cat. No. AS-40—1000-ohm—For Type 8 Monophone
- Cat. No. AS-41—2500-ohm—For Outdoor Monophone
- Cat. No. AS-42—1600-ohm—For Outdoor Monophone
- Cat. No. AS-43—1000-ohm—For Outdoor Monophone
- Cat. No. AS-44—2500-ohm—For Mine-Type Tel.
- Cat. No. AS-45—1600-ohm—For Mine-Type Tel.
- Cat. No. AS-46—Local-Battery Ringer—2500-ohm  
For Type 200 Wall Set, and Ringer Box.
- Cat. No. AS-47—Local-Battery Ringer—1600-ohm  
For Type 18 Monophone, Type 200 Wall Set, Ringer Box.
- Cat. No. AS-48—Local-Battery Ringer—1000-ohm  
For Type 18 Monophone, Type 200 Wall Set, Ringer Box.
- Cat. No. AS-49—1000-ohm—For Type 10 Monophone.
- Cat. No. AS-56—2500-ohm—For Ext. Rgr. AO-39
- Cat. No. AS-57—1600-ohm—For Ext. Rgr. AO-40
- Cat. No. AS-58—1000-ohm—For Ext. Rgr. AO-41
- Cat. No. AS-74—Local-Battery Ringer—2500-ohm  
For Type 371B Monophone, AO-65 Ringer Box, and Extension Ringer (Wood Box).

If mounting parts (screws, washers, etc.) are desired, please specify, and give catalog number of telephone or ringer box in which ringer is to be installed.



# Monotype Telephone Cords

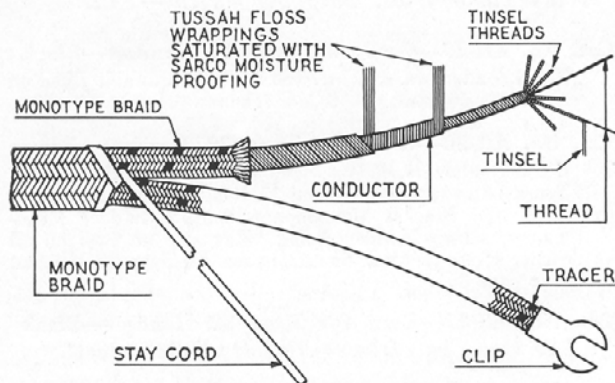

This Construction Gives Monotype Cords their Exceptional Characteristics

Monotype Cords are made to meet the most rigid specifications for insulation quality, handsome appearance, and long life. Their construction (shown in the above drawing) saturates the insulation of each conductor with a highly effective moisture-proofing compound. Over this are two layers of tightly woven braid, resulting in an insulation which will be found to meet all but the most severe climatic conditions. For replacing rubber-insulated cords on telephone instruments which are to be used out-of-doors, cords with rubber insulation will be supplied, if specified on order.

Monotype cords resist kinking, because the conductors are laid straight, not twisted. The conductors do not separate, and permanent kinks cannot form.

Monotype outer braid resists fraying—by actual tests, more than any other cord covering material. It is made of special cotton braid, very tightly woven to form a close, smooth covering.

Monotype cords have high insulation resistance—and retain it. They are not injured by accidental immersion or the most humid climatic conditions.

Monotype cords do not become noisy, because the tinsel conductors are wound on cotton thread in such a manner that the cotton takes all strain. And as the cords do not kink, the conductors do not separate and break, and do not develop noises.

Monotype cords can be supplied for use with any type of telephone instrument. The most widely used types are shown herewith, but if the cord you need is not shown, merely send an old cord as a sample (or a sketch showing trim, tracer colors and length) and tell us where it is to be used, giving other manufacturer's number, if known.

## Handset Cords

(See also the Extensicord, page 40)

*Net Weight—2 oz. Shipping Weight—6 oz.*

**Cat. No. AH-27—Cord for Type 41 Handset**

Three conductors, 53 inches long over all, black braid.

**Cat. No. AH-11—Cord for Type 38 Handset—Brown**

Can also be used on S-C Nos. 10 and 12 handsets, replacing S-C Co.'s Nos. C-3-B and MC-3-B. Three conductors, 53 inches long over all, brown braid.

**Cat. No. AH-30—Cord for Type 38 Handset—Black**

Like above, but with black braid.

## Receiver Cords

*Net Weight—1 oz. Shipping Weight—5 oz.*

**Cat. No. AR-33—Cord for Type 42 Receiver—Brown**

Two conductors, 33 inches long over all, brown braid.

**Cat. No. AR-34—Cord for Type 42 Receiver—Black**

Like above, but with black braid.

**Cat. No. AR-14—Cord for Type 23 Receiver**

Two conductors, 33 inches long over all, brown braid.

## Desk Stand Cords

*Net Weight—2 oz. Shipping Weight—6 oz.*

**Cat. No. AD-18—Cord for 40, 34A3B Monophones**

For metallic ringing. Two conductors, 72 inches long over all, black braid.

**Cat. No. AD-57—Cord for 40, 34A3B Monophones**

For ground ringing. Three conductors, 72 inches long over all, black braid.

**Cat. No. AD-13—Desk Stand Cord—Brown**

For Type 1A Monophone (C.B. or Magneto); Type 21A Desk Set; Bracket Monophone; Type 8 Monophone. Also for Type 21 Desk Set, Anti-Sidetone Ckt.; Type 19 Monophone. Four conductors, 72 inches long over all, brown braid.

**Cat. No. AD-40—Desk Stand Cord—Black**

Like above, but with black braid.

**Cat. No. AD-10—Desk Stand Cord**

Three conductors, 72 inches long over all, brown braid. For Type 1A Monophone, Ind.-Coil-Rec. Ckt.; also for Type 34A3 Monophone, Grd. Rg.; Type 21 Desk Sets, Reg. Booster and Series Ckts.; Type 200 Desk Sets.

**Cat. No. AD-12—Desk Stand Cord**

For Type 34A3 Monophone, Met. Rg.; also for Type 7 Monophone. Two conductors, 72 inches long over all, brown braid.

**Cat. No. AD-24—Desk Stand Cord**

Nine conductors, 72 inches long over all, brown braid. For Two-Line Monophones AA-24, AA-25, AA-44, AA-45.

**Cat. No. AD-14—Desk Stand Cord**

Eleven conductors, 72 inches long over all, brown braid. For Two-Line Monophones AA-22, AA-23, AA-26, AA-27.

## The Extensicord

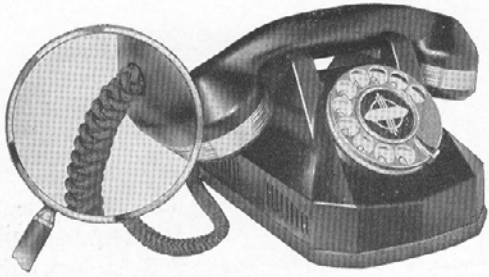

Here is a handset cord that actually s-t-r-e-t-c-h-e-s! It is normally only 32 inches long, and settles down close to the telephone when not in use. But when the handset is lifted, Extensicord stretches easily in a straight line, to almost twice its normal length. Thus, it permits the handset user to stand, sit down, or move about with exceptional freedom. When the handset is replaced, the cord returns to its normal shortened form—no kinking, twisting, or knotting, or getting snarled with other objects on the desk or table. Telephone subscribers welcome the convenience provided by this unique cord.

*Net Weight—3 oz. Shipping Weight—7 oz.*

- Cat. No. AH-29—Cord for Type 41 Handset—Black**  
Has 3 conductors, each covered with black braid. Used on Types 40, 50, and 34A3B Monophones.
- Cat. No. AH-20—Cord for Type 38 Handset—Brown**  
Has 3 conductors, each covered with brown braid. Use on Types 1A, 4A, 8, 10, 18, and 371B Monophones, in "Two-Line" and Bracket Monophones, and in Outdoor Monophones, shown in this catalog. May also be used on all earlier types of Monophones, using the Type 38 Handset (see page 36).
- Cat. No. AH-21—Cord for Type 38 Handset—Black**  
Like above, but conductors covered with black braid.
- Cat. No. AH-22—For W.E. No. E1B Handset—Brown**  
Replaces W.E.Co.'s No. H3B.
- Cat. No. AH-23—For Kellogg No. F27 Handset—Brown**  
Replaces Kellogg's No. F673-G.
- Cat. No. AH-31—For W.E. No. F1 Handset—Brown**  
Replaces W. E. Co.'s No. H3C9
- Cat. No. AH-32—For Leich Handset—Brown**
- Cat. No. AH-33—For S.-C. Handset—Brown**

## Coin Collectors

### Type 10

With this coin collector, the telephone user puts a nickel in the slot, and proceeds to dial his call. When the called party answers, a buzzer within the collector begins to sound; the calling party then operates a small lever, which deposits the coin in the cash box, before conversation can take place. The sound of the buzzer indicates to the called party that the call is from a pay-station, and that he should therefore wait on the line while the coin is deposited. Because of this positive signal to both parties, calls are completed rapidly, and calls are seldom lost because of delay in depositing coins.

The Type 10 Coin Collector does not require any special equipment at the central office—it may be used on any automatic line where "reverse-battery" supervision is given (except two-party "jack-per-station" lines).



The collector has a case of heavy sheet steel, finished in black japan. Two keys are required to open the coin collector and the cash box. The main key is identical for all coin collectors; the cash-box key is different for each coin collector (or you may have the same lock on any or all cash boxes if desired).

*Dims.—Height, 9 $\frac{1}{8}$ " ; width, 4 $\frac{1}{4}$ " ; depth, 3 $\frac{1}{2}$ ".*

### Cat. No. AJ-13—Type 10 Coin Collector

Takes U. S. nickels. For use with Monophones and Type 21A telephones having anti-sidetone or booster circuit.

NOTE: As the coin-collector short-circuits the telephone transmitter, and shunts the receiver, it is necessary to change the interior wiring of the telephone, and, in the case of desk-type instruments, to provide an additional conductor in the cord between desk stand and ringer box. Instruments arranged for this service can be supplied in all types.

### Type 29

Identical with Type 10, but without buzzer. The calling party hears the called station answer, and the coin must then be deposited quickly, as the called party has no indication that the call is from a pay-station.

### Cat. No. AJ-12—Type 29 Coin Collector

Takes U. S. nickels. For use with Monophones and Type 21A telephones having anti-sidetone or regular booster circuit (see note above).

## Telephone Accessories

### Telephone Switching Keys

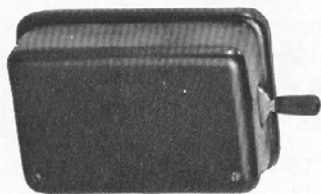

Used for connecting one telephone to two or more lines, connecting a number of telephones to one line, etc. Consists of a locking type lever key, assembled on a steel base and protected by a pressed steel cover, finished in black japan. Dimensions: length,  $5\frac{3}{4}$ " (including key handle); width,  $3\frac{3}{8}$ "; height,  $1\frac{1}{2}$ ".

Cat. No. AY-10—Switching Key—2-cond., 2-way  
Cat. No. AY-11—Switching Key—2-cond., 3-way

### Telephone Connecting Blocks

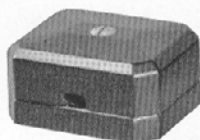

Cat. No. AV-19

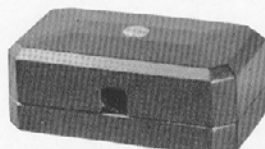

Cat. No. AV-20

Telephone Connecting Blocks

These small, handsome blocks, for use with self-contained telephones, etc., are molded of black plastic, with a permanently handsome finish. Cover has openings for cords and line wires; there is also a knockout in the base for bringing in line wires from directly under the block. A spring clip is provided, to clip around the telephone cord and take all strain from the cord terminals. Terminal screws are connected in pairs by metal straps molded into the material, and are plainly marked with embossed designations, highlighted with red enamel. Cover fastens with one "non-losable" screw, and two wood screws are provided for mounting the block.

#### Cat. No. AV-19—Type 11 (1-Pair) Connecting Block

For use with two-conductor cords. Length, 2 inches; width,  $1\frac{1}{2}$  inches; height,  $\frac{1}{8}$  inch.

#### Cat. No. AV-20—Type 12 (2-Pair) Connecting Block

Provides a terminal for ground-ringing on central-battery lines, or two terminals for battery connections on local-battery telephones, in addition to the terminals for line wires. Length,  $2\frac{5}{8}$  inches; width,  $1\frac{1}{2}$  inches; height,  $\frac{1}{8}$  inch.

### The Autodial

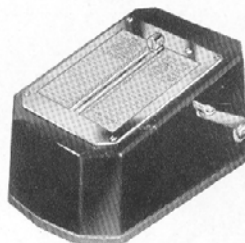

Above—52-station Autodial, Cat. No. AW-27



At right—12-station Autodial, Cat. No. AW-26

This ingenious new device dials telephone numbers automatically! Offer it to the busy executive, the active clubwoman, the aged or invalid—it means substantial extra revenue for your company.

To enjoy Autodial service, the telephone user gives you the names of the business and social acquaintances whom he calls most often. Their telephone numbers are then set up on the Autodial, and the names lettered on the directory card. To secure an immediate connection with any one of these stations, he has only to set the pointer at the desired name, and press a lever at the right of the Autodial. The machine automatically does the rest.

Autodial is finished in black japan, with exposed metal parts chromium plated. A black rubber cushion ring on the base protects highly polished surfaces. Base is  $5\frac{3}{4}$ " wide and  $9\frac{1}{4}$ " long.

*When ordering, send list of names with corresponding telephone numbers to be called.*

#### Cat. No. AW-26—Autodial—12-station model

With Monophone handset, Type 24A36 dial, and 3-winding induction coil, and wired in accordance with the anti-sidetone booster circuit. Can be used with any ringer box (no induction coil needed). Handset fitted with Extensicord; and 3-conductor Monotype cord, 6 feet long, is provided for connection to ringer box. Black-japanned transmitter and receiver bands, and dial finger plate, is standard, and is supplied unless otherwise ordered. Number plate, finger plate, and dial card as illustrated are regularly supplied (if other dial card or number plate, or "cutaway" finger plate, is desired, give catalog numbers).

#### Cat. No. AW-27—Autodial—52-station model

Complete with 5-conductor Monotype cord, 6 feet long. Can be used with any standard automatic telephone.

## Telephone Accessories

### Portable Telephone Plugs and Jacks

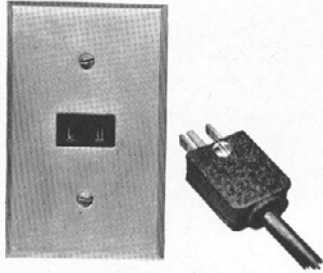

Plug AZ-10 (Cord is not Furnished)  
Jack and Flush Plate AZ-11

By offering portable telephones equipped with plugs, and wall jacks for installation at points where permanent telephones would not be desired, telephone companies can often secure increased revenues in clubs, hotels, large residences, etc. The Type 40 Monophone (see page 8), with its convenient finger grips and

chromium-plated lift handle (optional) is perfectly adapted for this service.

Portable telephone jacks are designed to mount in a standard electric switch box (not furnished) and are provided complete with a flush plate, finished in brushed brass.

Cat. No. AZ-10—Portable Telephone Plug—2-cond.

Cat. No. AZ-11—Jack and Flush Plate—2-cond.

Cat. No. AZ-12—Portable Telephone Plug—4-cond.

Cat. No. AZ-13—Jack and Flush Plate—4-cond.

### Battery Boxes



A neat and convenient means of mounting No. 6 dry cells. Have mounting holes in side. Made of sheet steel, black crackle finished, and with insulating lining.

No. S-3007—Box for 2 Dry Cells

No. S-3008—Box for 3 Dry Cells

## Operators' Sets

### Breastplate-Transmitter Type

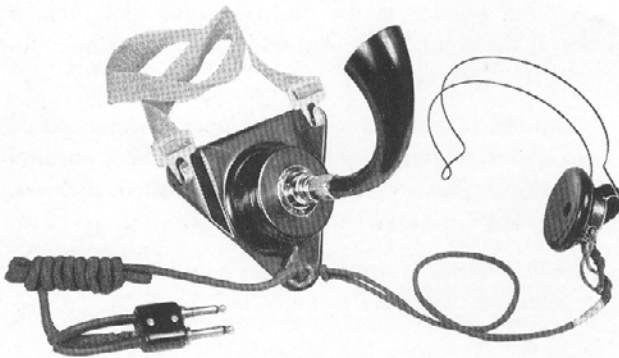

The breastplate-transmitter type operator's set consists of the transmitter with web strap, a receiver and headband, and a connecting cord with twin plug which fits Monotype or Western Electric switchboards. The transmitter is a special compact type, designed to operate efficiently in the many positions in which it will be placed when in service. The receiver headset was designed for the comfort of the operator, permitting use for long periods without fatigue.

*Net Weight*—1½ lbs. *Shipping Weight*—3 lbs.

Cat. No. DA-16—Operator's Breastplate Set

### Suspended-Transmitter Type

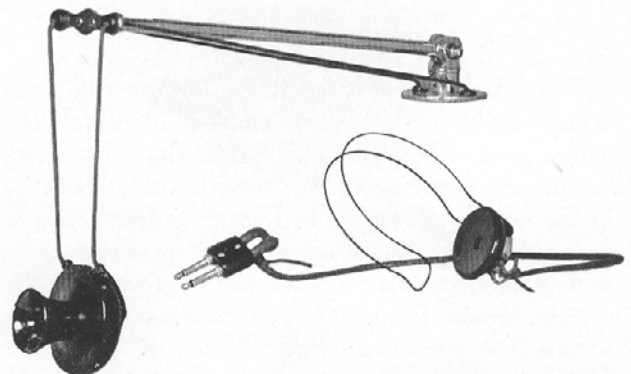

Complete set consists of the suspended transmitter with long cords and an adjustable transmitter arm finished in highly polished nickel plate, together with a headset with cord and plug as described at left.

Cat. No. DG-46—Transmitter, Cords, and Arm

Cat. No. DG-48—Headset, Cord, and Plug

### Operators' Cords

Cat. No. DB-13—Breastplate Set Cord—4-cond.

Cat. No. DT-14—Sus. Trans. Cord (1-cond.)—C.B.

Cat. No. DT-15—Sus. Trans. Cord (1-cond.)—L.B.

Cat. No. DA-20—Operator's Receiver Cord—2 cond.

## Conversion Kits

### For Type 21 Wall Telephone

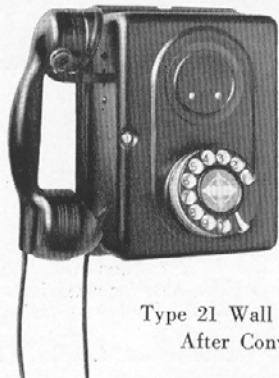

Type 21 Wall Telephone,  
After Conversion

Includes all the parts required for converting a Type 21 wall telephone into a modern Monophone. Kit consists of a black-japanned steel plate with mounting screws, for covering the transmitter hole, a Monophone hook for replacing the receiver hook, and a Monophone handset, complete with three-conductor cord.

Cat. No. AW-25—Conversion Kit for Type 21 Tel.

### For Magneto Wall Telephone

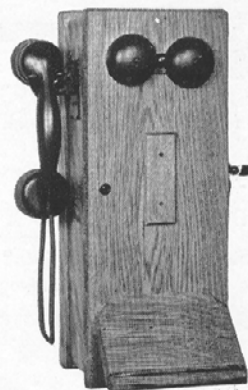

Typical Magneto  
Telephone,  
After Conversion

Magneto wall telephones, if in good condition, may be converted into Monophone sets by removing the transmitter and hookswitch, and substituting the parts supplied in this kit. Consists of a Monophone handset with special four-conductor cord, a complete new hookswitch and handset hook, and a small golden oak panel, for covering the transmitter mounting holes.

Cat. No. AW-23—Magneto Monophone Conversion Kit

## Hand Test Telephones

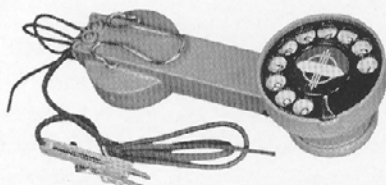

Hand Test Telephone  
Cat. No. TA-10

Used for general supervisory purposes in automatic exchanges. Handset, of aluminum alloy, contains transmitter and receiver, an impedance coil, a condenser, a 1200-ohm resistor, and two pushbuttons, and is equipped with a dial, and a two-conductor cord, 36 inches long, with test plug or clips. One button is pushed before connecting to a busy line, and prevents the direct current from shunting through the transmitter and thus causing a "click" or a loss of volume in the telephone being used. (The condenser prevents flow of direct current through the receiver). The other pushbutton puts the 1200-ohm resistance in series with the line, for testing automatic switches over a maximum resistance loop.

The dial is protected by a guard of heat-treated aluminum alloy, and the case of the telephone is drilled for a hook by which it can be carried from the belt. The hook is supplied separately, as listed below.

#### Cat. No. TA-10—Test Telephone, with Test Plug

Plug fits jacks on automatic switches, and is fitted with a pushbutton having a pair of "make" springs, for testing "battery-searching" type selectors. By pressing the button momentarily, the switch is prepared for following dial pulses.

#### Cat. No. TA-11—Test Telephone, with Test Clips

#### Cat. No. TA-12—Test Telephone, with Manual Plug

#### Cat. No. TA-54—Belt Hook, only

#### Cat. No. TA-13—Dial Guard, only

For Hand Test Telephone having Type 24 or Type 24A36 dials.

#### Cat. No. TA-14—Wall Mounting Bracket

May be mounted on wall, switchboard upright, etc.

#### Cat. No. AH-18—Cord for Test Tel. TA-10 or TA-11

Two-conductor cord, 36 inches long overall, for Test Telephones with automatic test plug, or test clips.

#### Cat. No. AH-19—Cord for Test Telephone TA-12

Two-conductor cord, 36 inches long overall, for Test Telephone with manual plug.

## Dial and Monophone Tools



Tool for Dial Escutcheon Lock  
Cat. No. AW-13

**Cat. No. AW-13—Dial Escutcheon Lock Tool**

**Cat. No. AW-14—End Wrench for Dial**

For dial governor nut, and large impulse cam nut.

**Cat. No. AW-15—Socket Wrench for Dial**

For small impulse cam nut.

**Cat. No. AW-16—Dial Pliers**

For adjusting dial springs and governor.

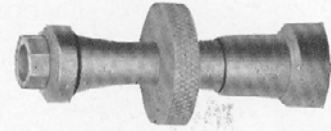

Monophone Tool  
Cat. No. AW-17

**Cat. No. AW-17—Monophone Tool**

For removing Monophone switch spanner nut on Types 50, 1A, 4A, 8, 10 and 18 Monophones, and on "Two-Line" and Bracket Monophones. Also for removing receiver cap bushing on Type 38 handset.

**Cat. No. AW-18—Monophone Cradle Wrench**

For removing cradle from Types 1A, 8, 10, and 18 and "Two-Line" Monophones.

## Parts for Type 40 Monophones

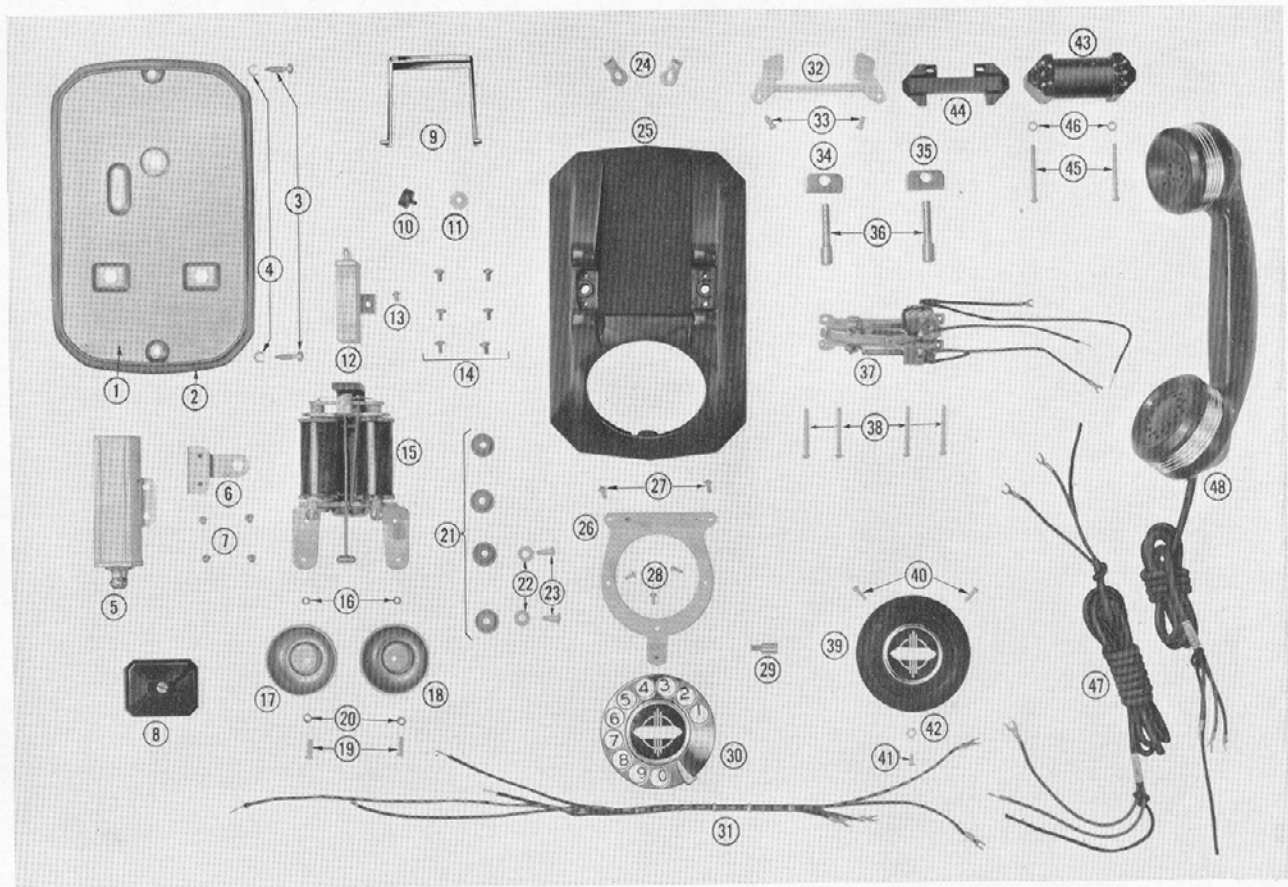

Do not order by above numbers—see table below.

Ref. No.	Description	Order by No.	Ref. No.	Description	Order by No.
1	Baseplate	D-780093	26	Dial Bracket	D-731021
2	Rubber Cushion	D-67251-A	27	Dial Bracket Screw (2 Required)	6-32x $\frac{1}{4}$ " RHIMS
3	Baseplate Screw (2 Required)	D-760069	28	Dial Mounting Screw (3 Required)	4-36x $\frac{1}{4}$ " RHIMS
4	Ring for Baseplate Scr. (2 Req'd.)	D-65270	29	Screw Stud	D-760100
5	Transmission Condenser (5 mf.)	D-68258-A	30	Dial	AK-56
6	Bracket for 5 mf. Condenser	D-731018		(For parts, see p. 54)	
7	Condenser Mounting Scr. (4 Req'd.)	6-32x $\frac{1}{8}$ " RHIMS	31	Formed Cable	H-47894-1
8	Terminal Block—Metallic Ringing Ground Ringing	AV-19	32	Bracket for Induction Coil	D-730987
9	Lift Handle	AV-20	33	Bracket Mounting Screw (2 Req'd.)	6-32x $\frac{5}{16}$ " RHIMS
10	Bumper Screw	D-780188-A	34	Mounting Block (Left)	D-660025-A
11	Washer for Bumper Screw	D-760151	35	Mounting Block (Right)	D-660026-A
		D-17473	36	Switch Plunger (2 Required)	D-67313-A
12	Ringing Condenser (1 mf.)	D-68247-B	37	Monophone Switch	D-735244-A
13	Condenser Mounting Screw	6-32x $\frac{3}{16}$ " RHIMS	38	Switch Mounting Screw (4 Req'd.)	5-40x $1\frac{1}{4}$ " RHIMS
14	Terminal Screw (6 Required)	D-76279-A	39	Dial Blank—Black	D-49609-A
15	Ringer—Straight-Line (For Ringer Movements—S.L. and Harm—see p. 38)	D-56441-A	40	Dial Blank Mtg. Screw (2 Req'd.)	4-40x $\frac{3}{8}$ " RHIMS
			41	Screw for Dial Blank	4-40x $\frac{1}{4}$ " RHIMS
16	Gong Spacer (2 Required)	D-65334	42	Shakeproof Washer	D-17377-A
17	Gong (Light)	D-56438	43	Induction Coil—Regular Super-Volume	D-282996
18	Gong (Heavy)	D-56439	44	Armature for Induction Coil	D-282805-A
19	Gong Mounting Screw (2 Req'd.)	D-760099-A	45	Ind. Coil Mounting Screw (2 Req'd.)	D-71485-A
20	Shakeproof Washer (2 Required)	D-17464-A	46	Shakeproof Washer (2 Required)	5-40x $1\frac{1}{16}$ " RHIMS
					D-17468-A
21	Rubber Washer (4 Required)	D-17443	47	Desk Set Cord—2-cond. (Met.Rg.) 3-cond. (Grd.Rg.)	AD-56
22	Washer (2 Required)	D-17445			AD-57
23	Ringer Mounting Screw (2 Req'd.)	D-760068	48	Type 41 Handset—Regular Super-Vol.	AF-48
24	Cord Clip (2 Required)	D-542637			AF-47
25	Base—Black (or other on order)	AW-29		(For parts, see p. 55)	

For the Type 40 Desk Monophone, see pp. 8-9.

## Parts for Type 50 Monophones

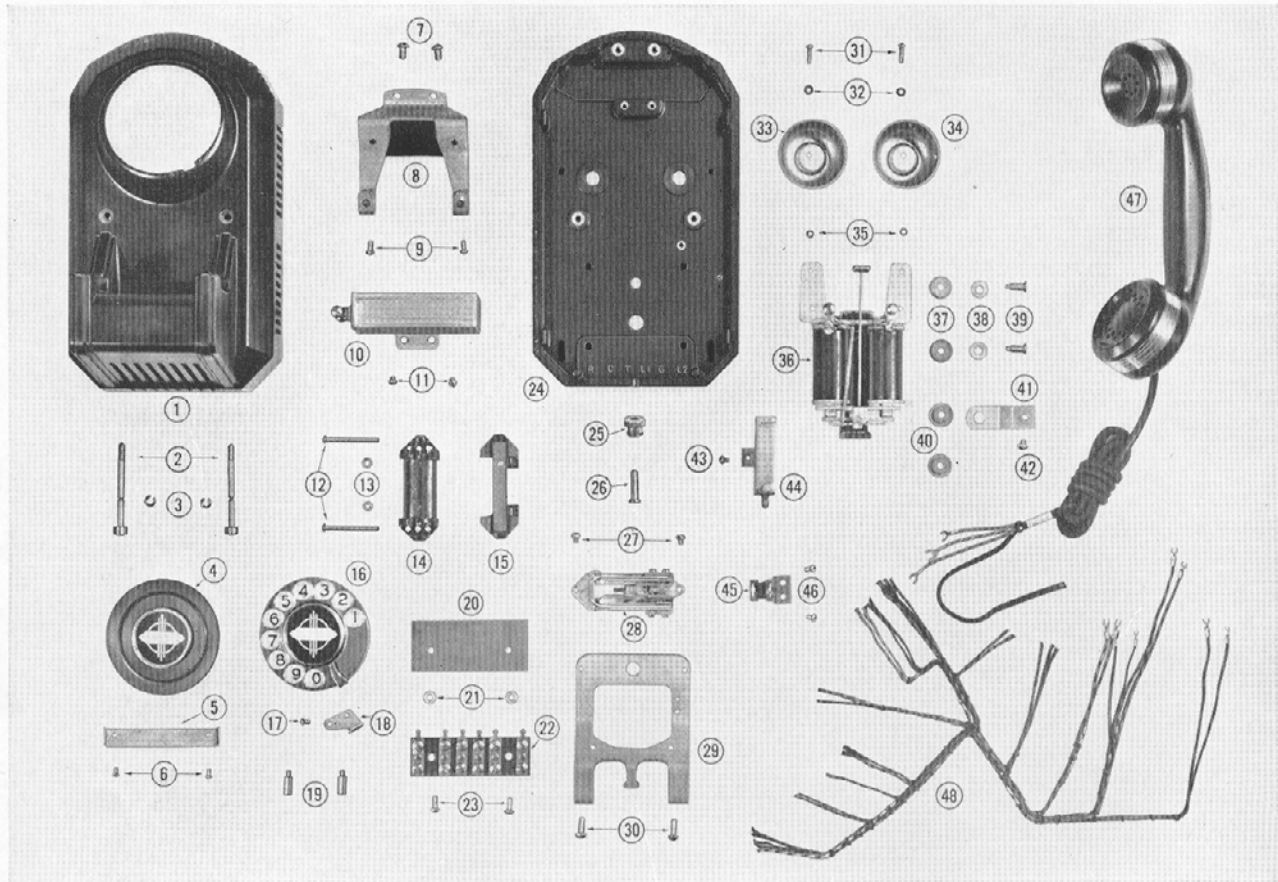

Do not order by above numbers—see table below.

Ref. No.	Description	Order by No.	Ref. No.	Description	Order by No.
1	Cover—Black (or other on order)	AW-30	26	Switch Plunger	D-41293-C
2	Cover Screw (2 Required)	D-76655-C	27	Switch Mounting Screw (2 Req'd.)	6-32x $\frac{3}{16}$ " RHIMS
3	Lock Ring for Cover Screw (2 Req'd.)	D-65270	28	Monophone Switch	D-731066-A
4	Dial Blank—Black	D-49612-A	29	Bracket for Monophone Switch	D-731063
5	Dial Blank Mounting Strip	D-730848	30	Screw for Switch Brkt. (2 Req'd.)	10-32x $\frac{7}{16}$ " RHIMS
6	Dial Blank Mtg. Screw (2 Req'd.)	4-40x $\frac{3}{16}$ " RHIMS	31	Gong Mounting Screw (2 Required)	D-760099-A
7	Screw for Dial Bracket (2 Req'd.)	10-32x $\frac{3}{16}$ " RHIMS	32	Shakeproof Washer (2 Required)	D-17464-A
8	Dial Bracket	D-731065-A	33	Gong (Light)	D-56438
9	Dial Locking Screw (2 Required)	6-32x $\frac{5}{16}$ " RHIMS	34	Gong (Heavy)	D-56439
10	Transmission Condenser (5 mf.)	D-68258-A	35	Gong Spacer (2 Required)	D-65334
11	Condenser Mtg. Screw (2 Req'd.)	6-32x $\frac{1}{8}$ " RHIMS	36	Ringer—Straight-Line (For Ringer Movements—S.L. and Harm.—see p. 38)	D-56441-A
12	Ind. Coil Mtg. Screw (2 Req'd.)	5-40x $1\frac{1}{2}$ " RHIMS	37	Rubber Washer (2 Required)	D-17443
13	Shakeproof Washer (2 Required)	D-17468-A	38	Washer for Ringer Mtg. (2 Req'd.)	D-17428-A
14	Induction Coil—Regular Super-Volume	D-282996 D-282805-A	39	Screw for Ringer Mtg. (2 Req'd.)	D-760130
15	Armature for Induction Coil	D-71485-A	40	Rubber Ringer Stop (2 Required)	D-75887
16	Dial (For parts, see p. 54)	AK-56	41	Ringer Stop Bracket	D-731085
17	Screw for Mounting Dial Lug	4-36x $\frac{3}{16}$ " RHIMS	42	Ringer Stop Bracket Screw	8-32x $\frac{3}{16}$ " RHIMS
18	Lug for Dial	D-70162-C	43	Ringing Condenser (1 mf.)	D-68247-B
19	Dial Mounting Stud (2 Required)	D-76838	44	Condenser Mounting Screw	6-32x $\frac{3}{16}$ " RHIMS
20	Insulator for Terminal Strip	D-440071	45	Resistance Coil	D-282804-A
21	Terminal Strip Spacer (2 Req'd.)	D-17197	46	Coil Mounting Screw (2 Req'd.)	6-32x $\frac{3}{16}$ " RHIMS
22	Terminal Strip	D-15807-A	47	Type 41 Handset—Regular Super-Volume	AF-48 AF-47
23	Mounting Screw (2 Required)	6-32x $\frac{3}{8}$ " RHIMS	48	Formed Cable (For parts, see p. 55)	II-65275
24	Base—Black (or other on order)	D-47830-A			
25	Spanner Nut for Monophone Switch	D-77210-C			

For the Type 50 Wall-Mounting Monophone, see pp. 10-11.



## Parts for Type 1A Monophones

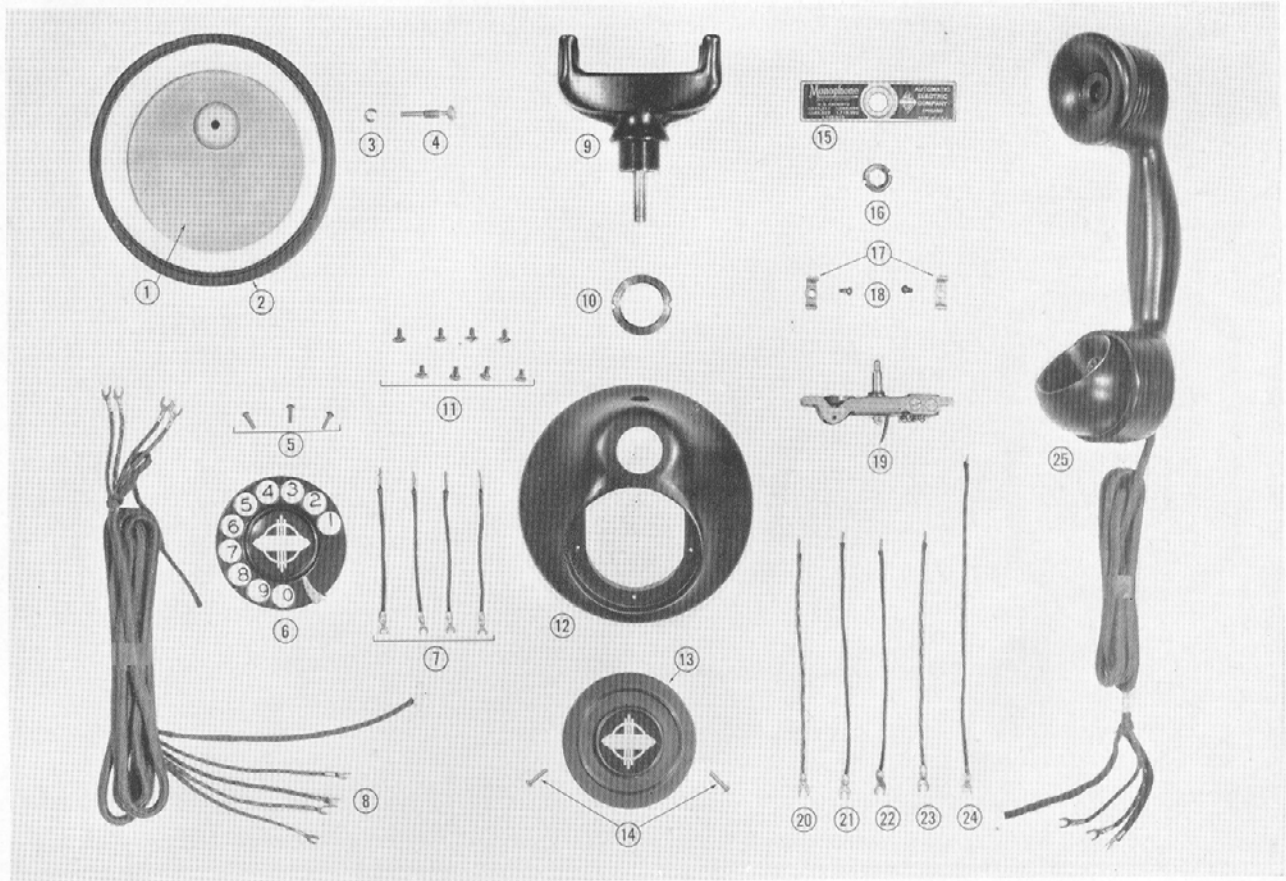

Do not order by above numbers—see table below.

Ref. No.	Description	Order by No.	Ref. No.	Description	Order by No.
1	Baseplate	D-78532	13	Dial Blank—Black	D-49607-A
2	Rubber Cushion	D-67122-A	14	Dial Blank Mtg. Screw (2 Reqd.)	4-40x $\frac{1}{2}$ " RHIMS
3	Lock Ring for Cover Screw	D-65270	15	Name Plate	D-78889-A
4	Cover Screw	D-76284	16	Spanner Nut for Name Plate	D-77091-A
5	Dial Mounting Screw (3 Required)	4-36x $\frac{3}{8}$ " RHIMS	17	Clamp for Switch (2 Required)	D-730204
6	Dial (For parts, see p. 54)	AK-11	18	Clamp Mounting Screw (2 Reqd.)	5-40x $\frac{3}{16}$ " RHIMS
7	Dial Wire (4 Required)	D-542342-A	19	Monophone Switch	D-730478-A
8	Desk Set Cord	AD-13	20	Wire (Blk.-Or.)—Sw. to Term. 1	D-541942-A
9	Cradle—Black (or other on order)	D-62037-A	21	Wire (Blk.-Gr.)—Sw. to Term. 2	D-541944-A
10	Spanner Nut for Cradle	D-77090	22	Wire (Black)—Sw. to Term. 3	D-541943-A
11	Terminal Screw (8 Required)	D-76279-A	23	Wire (Blk.-Wh.)—Sw. to Term. 7	D-541946-A
12	Base—Black (or other on order)	D-47338-A	24	Wire (Blk.-Red)—Sw. to Term. 8	D-542280-A
			25	Type 38 Handset—Black (For parts, see p. 55)	AF-10

For the Type 1A Desk Monophone, see pp. 12-13.

## Parts for Type 34A3B Monophones

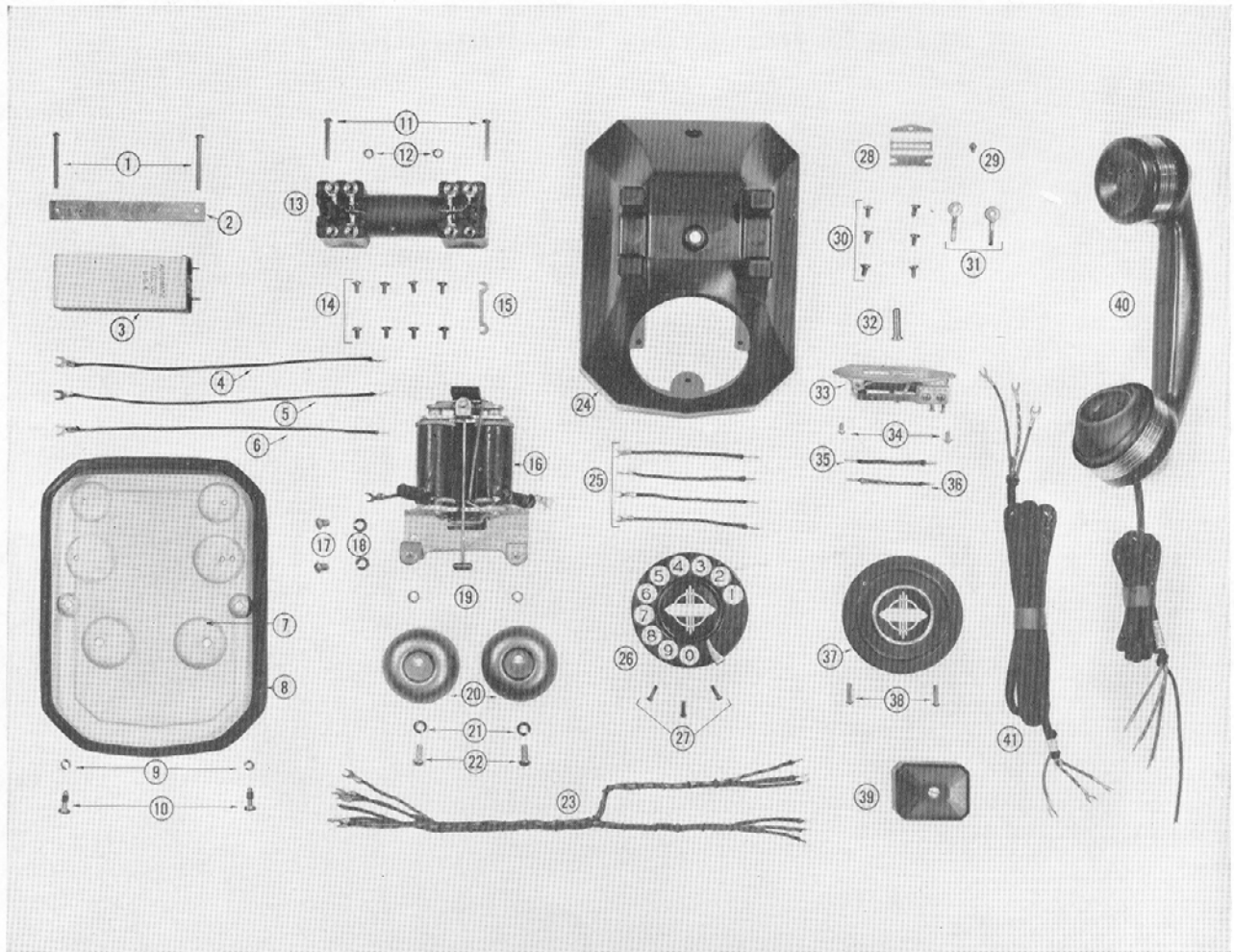

Do not order by above numbers—see table below.

Ref. No.	Description	Order by No.	Ref. No.	Description	Order by No.
1	Mounting Scr. (2 Reqd.)—1 Cond. 2 Conds.	5-40x1 3/4" RHIMS 5-40x1 3/8" RHIMS	22	Gong Mounting Screw (2 Required)	10-32x 1/16" RHIMS
2	Condenser Bracket	D-730693	23	Formed Cable—Metallic Ringing Ground Ringing	H-47823—1 H-47823—2
3	Condenser (1 Reqd. for Metallic Ring, 2 for Ground Ringing)	D-68197-A	24	Cover—Black (or other on order)	AW-31
4	Black Wire	D-542557-A	25	Dial Wires (4 Required)	D-542342-A
5	Red Wire	D-542558-A	26	Dial (For parts, see p. 54)	AK-11
6	Blue Wire (for Ground Ringing Only)	D-542559-A	27	Dial Mounting Screw (3 Required)	4-36x 3/8" RHIMS
7	Baseplate	D-78902	28	Cord Clamp	D-730816
8	Rubber Cushion	D-67251-A	29	Screw for Cord Clamp	6-32x 3/16" RHIMS
9	Lock Ring for Cover Screw (2 Reqd.)	D-65270	30	Terminal Screw (6 Required)	D-76279-A
10	Cover Screw (2 Required)	D-76639	31	Cord Lug	D-73261-A
11	Ind. Coil Mtg. Screw (2 Reqd.)	5-40x1" RHIMS	32	Switch Plunger	D-41293-A
12	Shakeproof Washer (2 Required)	D-17366-A	33	Monophone Switch	D-730813-A
13	Induction Coil	D-282155-A	34	Switch Mounting Screw (2 Reqd.)	6-32x 1/4" RHIMS
14	Terminal Screw (8 Required)	D-76279-A	35	Red Wire—Switch to Terminal "R"	D-542560-A
15	Link for Induction Coil	D-61050	36	White Wire—Switch to Terminal "C"	D-542561-A
16	Ringer—Straight-Line (For Ringer Movements—S.L. and Harm.—see p. 38)	D-56391-A Harm.—see p. 38)	37	Dial Blank—Black	D-49607-A
17	Ringer Mounting Screw (2 Reqd.)	10-32x 1/4" RHIMS	38	Dial Blank Mtg. Screw (2 Reqd.)	4-40x 1/2" RHIMS
18	Lock Washer (2 Required)	D-17149	39	Terminal Block—Metallic Ringing Ground Ringing	AV-19 AV-20
19	Gong Spacer (2 Required)	D-65280	40	Type 41 Handset—Black	AF-55
20	Gong (2 Required)	D-56328-A	41	Desk Set Cord—2-cond. (Met. Rg.) 3-cond. (Grd. Rg.)	AD-56 AD-57
21	Lock Washer (2 Required)	D-17149		(For parts, see p. 55)	

For the Type 34A3B Desk Monophone, see p. 16.

## Parts for Type 42 Wall Telephones

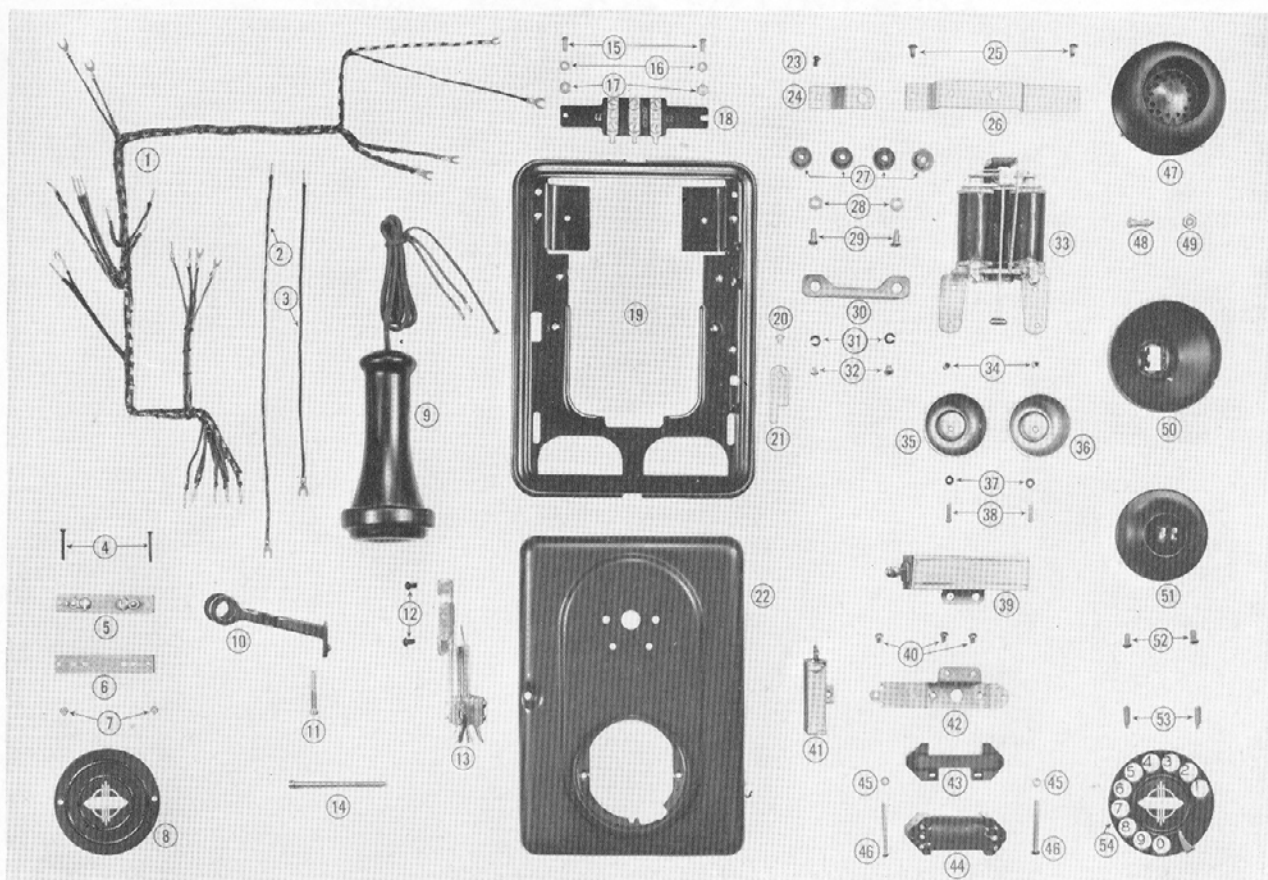

Do not order by above numbers—see table below.

Ref. No.	Description	Order by No.	Ref. No.	Description	Order by No.
1	Formed Cable	H-64851-1	30	Ringer Mounting Bracket	D-731114
2	Transmitter Cord (Blk. Or.)	D-541942-A	31	Lock Washer for Brkt. Scr. (2 Reqd.)	D-17195-B
3	Transmitter Cord (Black)	D-541681-A	32	Ringer Bracket Mtg. Scr. (2 Reqd.)	8-32x $\frac{3}{16}$ " RHIMS
4	Dial Blank Mtg. Screw (2 Reqd.)	D-76462-A	33	Ringer—Straight -Line (For Ringer Movements—S.L. and Harm.—see p. 38)	D-56441-A
5	Terminal Strip	D-310833-A			
6	Clamping Strip	D-310834			
7	Hex. Nut for Mtg. Scr. (2 Reqd.)	D-77075	34	Gong Spacer (2 Required)	D-653334
8	Dial Blank	D-49318-A	35	Gong (Light)	D-56438
9	Type 42 Receiver (For parts, see Type 21-A Desk Telephone, p. 50)	AF-52	36	Gong (Heavy)	D-56439
10	Receiver Hook	D-62034-B	37	Shakeproof Washer (2 Reqd.)	D-17464-A
11	Receiver Hook Pivot Screw	D-76280	38	Gong Mounting Screw (2 Required)	D-760099-A
12	Hookswitch Mtg. Scr. (2 Reqd.)	D-76288	39	Transmission Condenser (5 mf.)	D-68258-A
13	Hookswitch	D-731116-A	40	Condenser Mtg. Screw (3 Reqd.)	6-32x $\frac{3}{16}$ " RHIMS
14	Cover Locking Screw	D-76398	41	Ringind Condenser (1 mf.)	D-68247-B
15	Term. Strip Mtg. Scr. (2 Reqd.)	5-40x $\frac{5}{16}$ " RHIMS	42	Induction Coil and Cond. Bracket	D-731113
16	Washer (2 Required)	D-17221	43	Armature for Induction Coil	D-71485-A
17	Hex. Nut (2 Required)	D-77133-A	44	Induction Coil	D-282996-A
18	Terminal Strip	D-15645-A	45	Shakeproof Washer (2 Required)	D-17468-A
19	Baseplate	D-47425-A	46	Ind. Coil Mtg. Screw (2 Reqd.)	5-40x1 $\frac{1}{2}$ " RHIMS
20	Screw for Cover Latch	8-32x $\frac{3}{16}$ " RHIMS	47	Type 42 Transmitter (For parts, see Type 21-A Desk Telephone, p. 50)	AF-50
21	Cover Latch	D-5879	48	Hinge Pin	D-37169
22	Cover	D-49431-A	49	Nut for Hinge Pin	D-77078
23	Ringer Stop Bracket Screw	8-32x $\frac{3}{16}$ " RHIMS	50	Transmitter Shell	D-52023-B
24	Ringer Stop Bracket	D-731085	51	Transmitter Mounting Plate	D-78457-A
25	Ringer Support Brkt. Scr. (2 Reqd.)	8-32x $\frac{1}{4}$ " RHIMS	52	Transmitter Mtg. Screw (2 Reqd.)	8-32x $\frac{3}{16}$ " RHIMS
26	Ringer Support Bracket	D-731115	53	Dial Mounting Screw (2 Required)	D-76838
27	Rubber Washer (4 Required)	D-17443	54	Dial (For parts, see p.	AK-11
28	Washer for Ringer Mtg. (2 Reqd.)	D-17445			
29	Screw for Ringer Mtg. (2 Reqd.)	D-760068			

For the Type 42 Wall Telephone, see p. 18.

## Parts for Type 21A Desk Stands

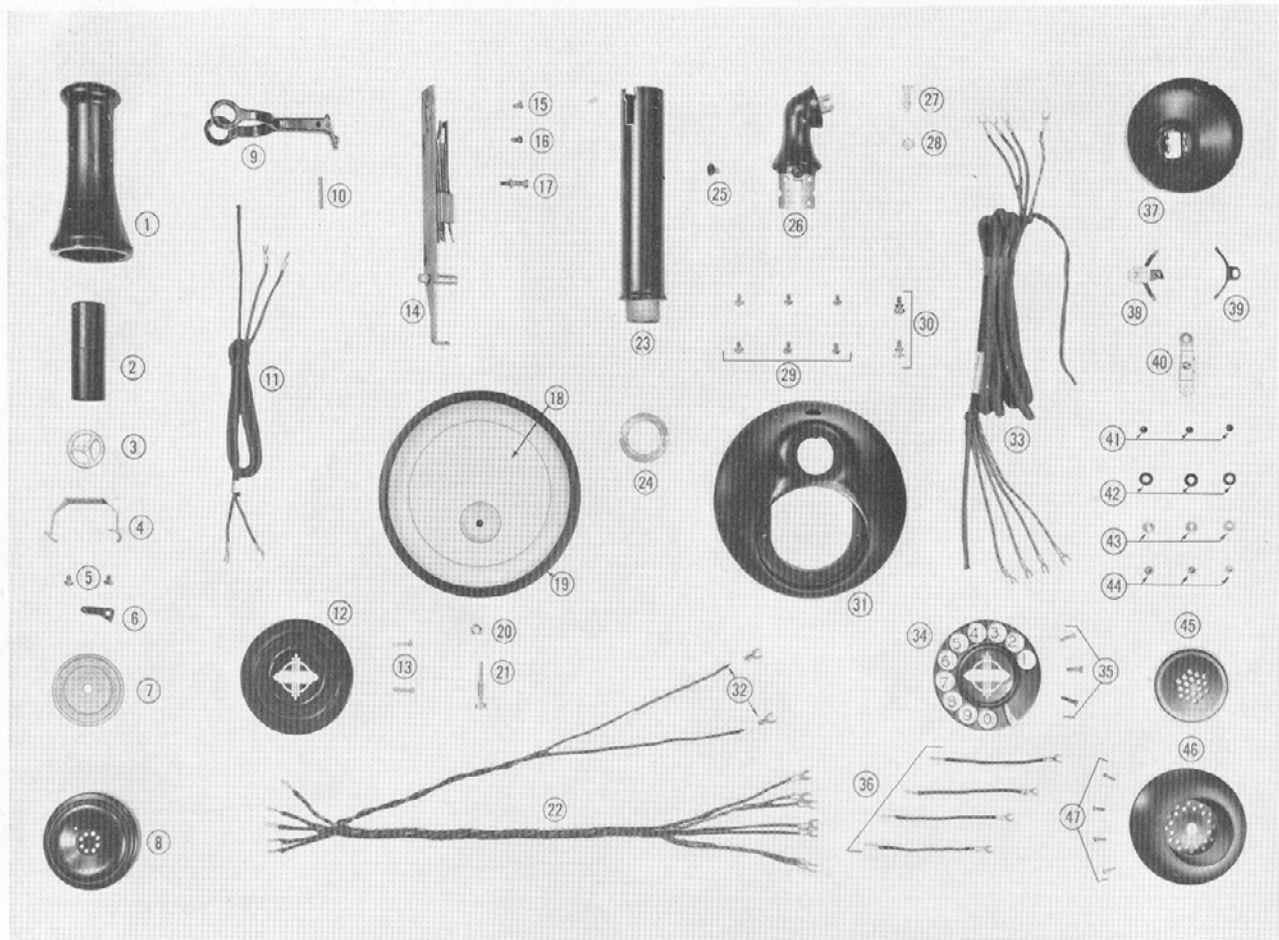

Do not order by above numbers—see table below.

Ref. No.	Description	Order by No.	Ref. No.	Description	Order by No.
1	Receiver Shell	D-52110-A	25	Locating Screw	D-76282
2	Receiver Weight	D-542713	26	Transmitter Mounting Elbow	D-36027-A
3	Retaining Ring	D-65365	27	Hinge Pin	D-37169
4	Receiver Clip Spring	D-109535	28	Nut for Hinge Pin	D-77078
5	Terminal Screw (2 Required)	D-76351-A	29	Terminal Screw (6 Required)	D-76279
6	Receiver Contact Spring	D-109482	30	Cord Holder Screw (2 Required)	D-76283
7	Type 41 Receiver Capsule	AF-54	31	Base	D-47338-A
8	Ear Cap	D-67330	32	Lug for Transmitter Wires (2 Req.)	D-15111
9	Receiver Hook	D-62034-B	33	Desk Set Cord	AD-13
10	Receiver Hook Pivot Pin	D-37171-B	34	Dial	AK-11
11	Receiver Cord	AR-33	35	Dial Mounting Screw (3 Required)	4-36x $\frac{3}{8}$ " RHIMS
12	Dial Blank	D-49607-A	36	Dial Wire (4 Required)	D-542342-A
13	Dial Blank Mtg. Screw (2 Req.)	4-40x $\frac{1}{2}$ " RHIMS	37	Transmitter Shell	D-52023-B
14	Hookswitch	D-78458-A	38	Transmitter Clip and Tem. Spring	D-109529
15	Flat-Hd. Screw for Mounting Elbow	6-32x $\frac{1}{4}$ " FHIMS	39	Transmitter Clip Spring	D-109509
16	Rd.-Hd. Screw for Mounting Elbow	6-32x $\frac{1}{4}$ " RHIMS	40	Transmitter Contact Spring	D-109526
17	Cord Separator Screw	D-76281	41	Insulating Bushing (3 Required)	D-7534
18	Base Plate	D-78532	42	Insulating Washer (3 Required)	D-440074
19	Rubber Cushion	D-67122-A	43	Metal Washer (3 Required)	D-17198
20	Lock Ring for Baseplate Screw	D-65270	44	Hex. Nut (3 Required)	D-7795-B
21	Baseplate Screw	D-76284	45	Type 41 Transmitter Capsule	AF-53
22	Formed Cable	H-50934-1	46	Transmitter Front	D-38301-A
23	Post	D-36031	47	Mounting Screw (4 Required)	D-760129-A
24	Spanner Nut	D-77090			

For the Type 21A Desk Telephone, see p. 20.

## Parts for Type 21A Wall Telephones

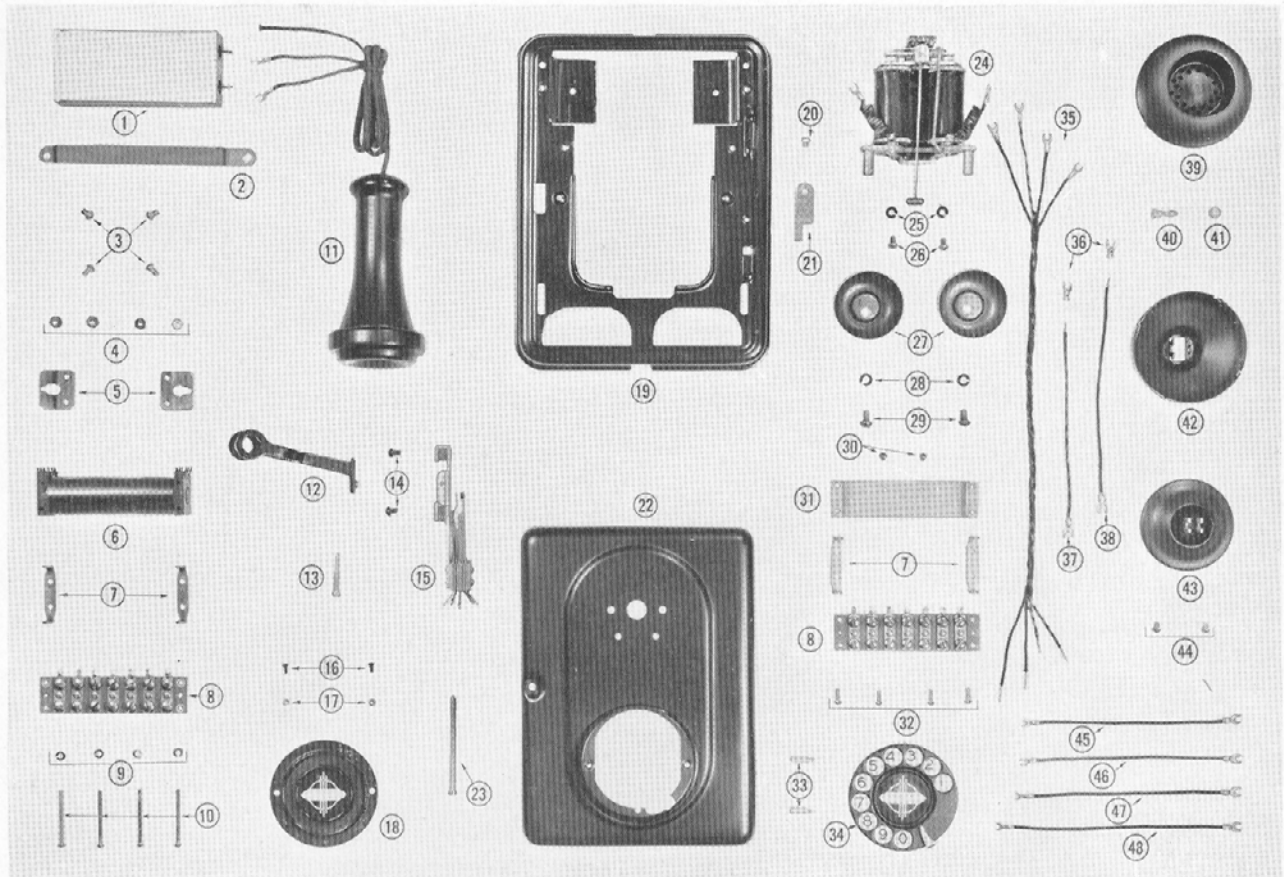

Do not order by above numbers—see table below.

Ref. No.	Description	Order by No.	Ref. No.	Description	Order by No.
1	Condenser (1 Req'd. for Metallic Ringing, 2 for Ground Ringing)	D-68197-A	24	Ringer—Straight-Line (For Ringer Movements—S.L. and (For parts, see pp. 56 and 57)	D-56329-A
2	Condenser Bracket—1 Condenser 2 Condensers	D-73684	25	Lock Washer (2 Required)	Harm.—see p. 38
3	Condenser and Induction Coil Bracket Screw (4 Required)	D-730100	26	Ringer Mounting Screw (2 Req'd.)	D-17195-B
4	Hex. Nut (4 Required)	D-73687	27	Gong (2 Required)	8-32x $\frac{1}{4}$ " RHIMS
5	Induction Coil Bracket (2 Req'd.)	D-73687	28	Lock Washer (2 Required)	D-56328-A
6	Induction Coil	D-281901-A	29	Gong Mounting Screw (2 Required)	D-17149
7	Cord Holder (4 Required)	D-541670	30	Term. Strip Brkt. Scr. (2 Req'd.)	10-32x $\frac{3}{8}$ " RHIMS
8	Terminal Strip (2 Required)	D-15513-A	31	Terminal Strip Bracket	6-32x $\frac{1}{8}$ " RHIMS
9	Lock Washer (4 Required)	D-17194-B	32	Term. Strip Mtg. Scr. (4 Req'd.)	D-73686
10	Ind. Coil Mtg. Screw (4 Req'd.)	5-40x1 $\frac{1}{16}$ " RHBMS	33	Dial Mounting Stud (2 Required)	6-32x $\frac{3}{8}$ " RHIMS
11	Type 42 Receiver (For parts, see Type 21-A Desk Telephone, p. 50)	AF-52	34	Dial	AK-11
12	Receiver Hook	D-62034-B	35	Formed Cable	H-50453-1
13	Receiver Hook Pivot Screw	D-76280	36	Lug for Transmitter Wires (2 Req'd.)	D-15111-A
14	Hookswitch Mtg. Scr. (2 Req'd.)	D-76288	37	Transmitter Wire (Black)	D-541681-A
15	Hookswitch	D-730502-A	38	Transmitter Wire (Blk.-Or.)	D-541942-A
16	Dial Blank Mtg. Screw (2 Req'd.)	D-76292	39	Type 42 Transmitter (For parts, see Type 21-A Desk Telephone, p. 50)	AF-50
17	Hex. Nut (2 Required)	D-77075	40	Hinge Pin	D-37169
18	Dial Blank	D-49318-A	41	Nut for Hinge Pin	D-77078
19	Baseplate	D-47425-A	42	Transmitter Shell	D-52023-B
20	Screw for Cover Latch	8-32x $\frac{3}{16}$ " RHIMS	43	Transmitter Mounting Plate	D-78457-A
21	Cover Latch	D-5879	44	Transmitter Mtg. Screw (2 Req'd.)	8-32x $\frac{3}{16}$ " RHIMS
22	Cover	D-49431-A	45	Dial Wire (Gr.-Red)	D-541919-A
23	Cover Locking Screw	D-76398	46	Dial Wire (Gr.-Wh.)	D-541922-A
			47	Dial Wire (Black)	D-541924-A
			48	Dial Wire (Gr.-Or.)	D-542254-A

For the Type 21A Wall Telephone, see p. 21.

## Parts for Type 200 Wall Telephones

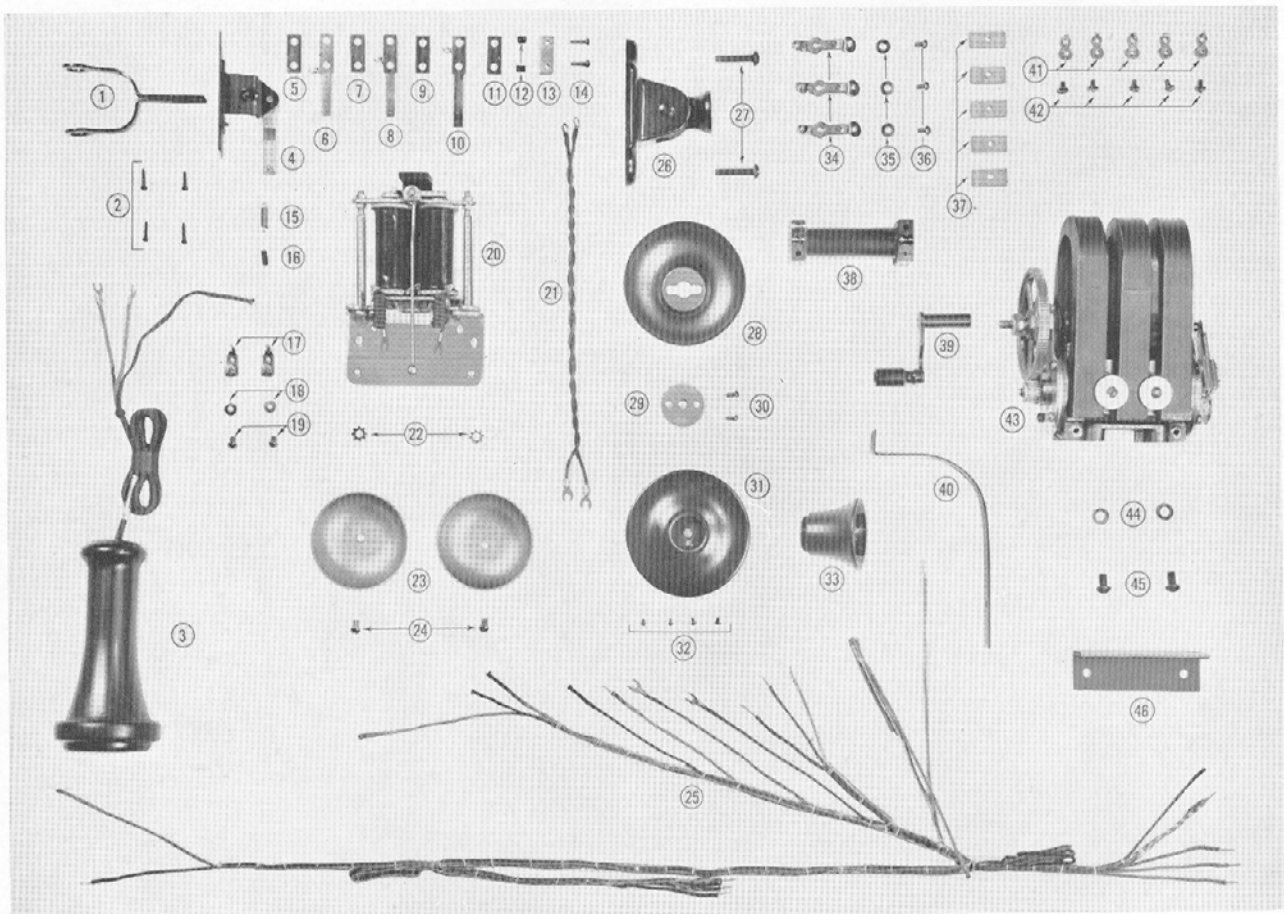

Do not order by above numbers—see table below.

Ref. No.	Description	Order by No.	Ref. No.	Description	Order by No.
1	Receiver Hook	MP-4395	24	Gong Mounting Screw (2 Required)	10-32x $\frac{1}{4}$ " RHBMS
2	Hookswitch Mtg. Screw (4 Reqd.)	No. 4x $\frac{1}{2}$ " RHIWS (Blk.)	25	Formed Cable	MP-4668
3	Receiver	AF-31	26	Transmitter Arm	MC-1610
4	Hookswitch Frame	MP-4380	27	Mounting Screw (2 Required)	No. 12-24x1" RHIMS (Blk.)
5	Hookswitch Spring Insulator	MP-511	28	Transmitter Cup	MP-4248
6	Hookswitch Spring	MP-4399	29	Three-Hole Washer	AP-523
7	Hookswitch Spring Insulator	MP-511	30	Mounting Screw (2 Required)	5-40x $\frac{1}{4}$ " RHBMS
8	Hookswitch Spring	MP-4410	31	Type 6 Transmitter	AF-21
9	Hookswitch Spring Insulator	MP-511	32	Transmitter Mtg. Screw (4 Reqd.)	D-76217
10	Hookswitch Spring	MP-4664	33	Transmitter Mouthpiece	AF-23
11	Hookswitch Spring Insulator	MP-511	34	Line Connector (3 Required)	AP-5915
12	Insulating Bushings (2 Required)	D-75511	35	Washer for Connector (3 Reqd.)	MP-623
13	Two-Hole Washer	MP-4382	36	Screw for Connector (3 Required)	8-32x $\frac{1}{4}$ " RHBMS
14	Spring Mounting Screw (2 Req.)	4-36x $\frac{1}{2}$ " RHIMS	37	Wire Clamp (5 Required)	MP-937
15	Coil Spring	MP-4868	38	Induction Coil	MC-2888
16	Insulating Bushing	MP-4389	39	Generator Crank	MP-123
17	Connector for Rec. Cord (2 Reqd.)	AP-5900	40	Generator Mounting Strap	AP-4557
18	Washer for Connector (2 Required)	AP-3642	41	Con. for Ringer & Trans. (5 Reqd.)	MP-2902
19	Screw for Connector (2 Required)	6-32x $\frac{3}{16}$ " RHIBMS	42	Screw for Connector (5 Required)	D-76279
20	Ringer—2500-ohm 1600-ohm 1000-ohm	AS-46 AS-47 AS-48	43	Generator—3-bar 5-bar	AC-9092 AC-90116
21	Transmitter Cord	MC-5416	44	Lock Washer (2 Required)	D-17026
22	Shakeproof Washer (2 Required)	MP-4068	45	Generator Mtg. Screw (2 Reqd.)	12-24x $\frac{3}{8}$ " RHIMS
23	Gong (2 Required)	D-56166-A	46	Generator Bracket	MP-4219

NOTE—This list does not include cabinet, mounting screws, etc.

For the Type 200 Wall Telephone, see p. 27.

## Parts for Ringer Boxes

Do not order by reference numbers—see tables below.

### Type 32 Compact Ringer Boxes

Ref. No.	Description	Order by No.
1	Cover	D-49488-A
2	Ringer—Straight-Line (For Ringer Movements—S.L. and (For parts, see pp. 56 and 57)	D-56329-A Harm.—see p. 38)
3	Bracket Mounting Screw (2 Reqd.)	10-32x $\frac{3}{8}$ " RHIMS
4	Lock Washer (2 Required)	D-17149-A
5	Ringer Bracket	D-730630
6	Lock Washer for Ringer (2 Reqd.)	D-17195-B
7	Ringer Mounting Screw (2 Reqd.)	8-32x $\frac{5}{16}$ " RHIMS
8	Gong (2 Required)	D-56328-A
9	Lock Washer for Gong (2 Reqd.)	D-17149-A
10	Stud for Gong (2 Reqd.)	D-19193
11	Cover Screw (2 Required)	D-76655-A
12	Lock Ring for Cover Screw (2 Reqd.)	D-65270
13	Term. Strip Mtg. Screw (2 Reqd.)	5-40x $\frac{1}{4}$ " RHIMS
14	Washer for Term. Strip (2 Reqd.)	D-1724-A
15	Terminal Strip	D-15645-A
16	Ind. Coil Mtg. Stud (2 Reqd.)	D-19195
17	Induction Coil—2-winding 3-winding	D-282332 D-282155-A
18	Terminal Screw (7 Required)	D-76279-A
19	Induction-Coil Link	D-61050
20	Tie Cord and Terminal Screw	D-76283
21	Base	D-47591-A
22	Wire (Black)	D-542431-A
23	Wire (Blk-Red)	D-542432-A
24	Wire (Blk.-Or.)	D-542531-A
25	Wire (Blk.-Bl.)—(Grd.-rg. only)	D-541833-A
26	Screw for Cond. Bracket (1 or 2)	5-40x $\frac{1}{4}$ " RHIMS
27	Condenser Bracket (1 or 2 Reqd.)	D-730626
28	Condenser (1 or 2 Required)	D-68197-A

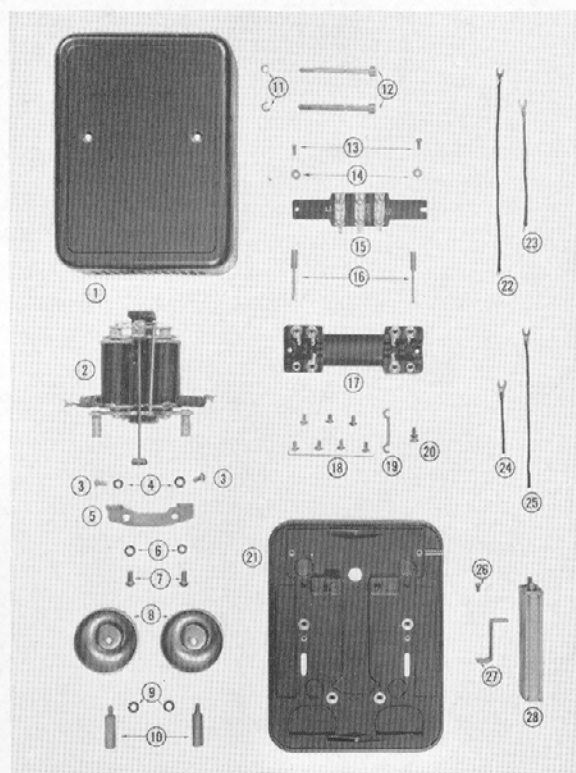

### Metal Ringer Boxes

Ref. No.	Description	Order by No.
1	Condenser Mtg. Screw (2 Reqd.)	8-32x $\frac{1}{4}$ " RHIMS
2	Condenser Bracket—1 Condenser —2 Condensers	D-73684 D-730100
3	Condenser (1 Reqd. for Metallic Ringing, 2 for Ground Ringing)	D-6897
4	Cord Holder (2 Required)	D-541670
5	Induction Coil—2-winding 3-winding	D-281897-A D-281901-A
6	Bracket Mounting Screw (2 Reqd.)	8-32x $\frac{1}{4}$ " RHIMS
7	Induction Coil Bracket (2 Reqd.)	D-73687
8	Terminal Strip	D-15513-A
9	Baseplate	D-47425-A
10	Cover Latch	D-5879
11	Screw for Cover Latch	8-32x $\frac{3}{16}$ " RHIMS
12	Cover Locking Screw	D-76398
13	Cover	D-49414-A
14	Hex. Nut for Mtg. Scr. (4 Reqd.)	D-77133-A
15	Spring Washer (4 Reqd.)	D-17194-B
16	Coil and Term. Mtg. Scr. (4 Reqd.)	5-40x1 $\frac{3}{16}$ " RHBMS
17	Lock Washer (2 Required)	D-17195-B
18	Ringer Mounting Screw (2 Reqd.)	8-32x $\frac{1}{4}$ " RHIMS
19	Ringer—Straight-Line (For Ringer Movements—S. L. and (For parts, see pp. 56 and 57)	D-56329-A Harm.—see p. 38)
20	Gong (2 Required)	D-56328-A
21	Lock Washer for Gong (2 Reqd.)	D-17149-A
22	Gong Mounting Screw (2 Required)	10-32x $\frac{3}{8}$ " RHIMS

For Complete Ringer Boxes, see p. 29.

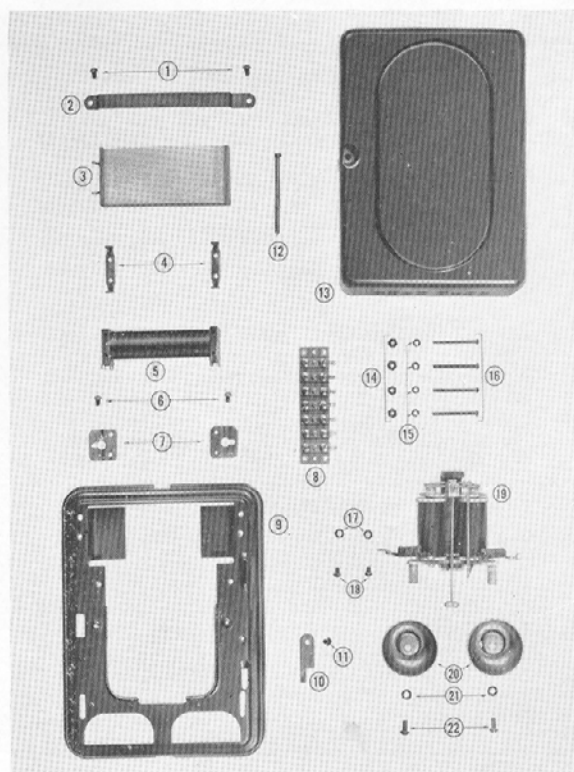

## Parts for Standard Type 24A36 Dials

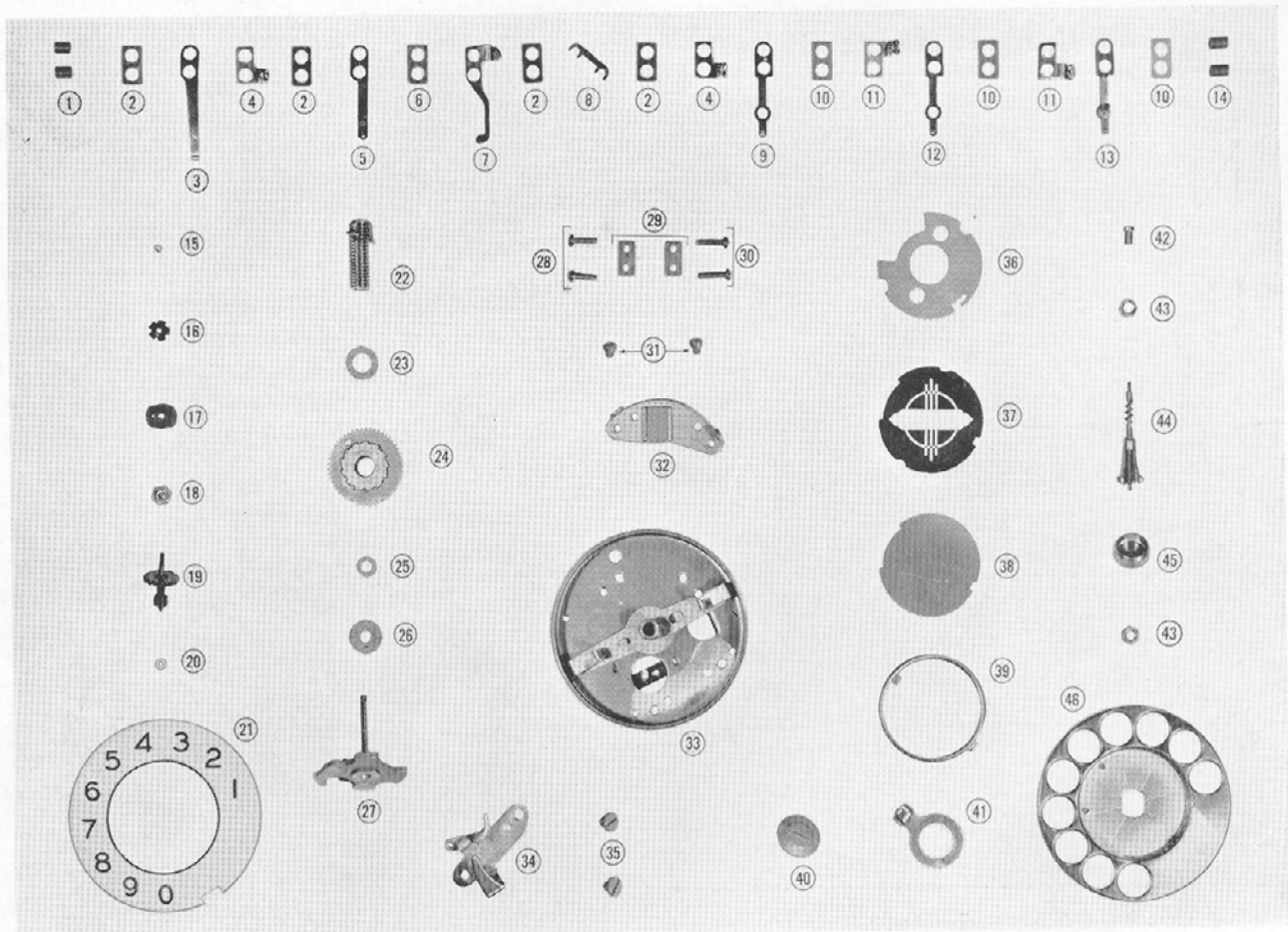

Do not order by above numbers—see table below.

Ref. No.	Description	Order by No.	Ref. No.	Description	Order by No.
1	Bushing for Spring Assy. (2 Reqd.)	D-75511	25	Small Fibre Washer	D-17424
2	Insulator (4 Required)	D-17216-A	26	Upper Thrust Washer	D-17218
3	Impulse Spring	D-107255	27	Shaft Assembly	D-46470-A
4	Terminal Assembly (2 Required)	D-15465-A	28	Screw for Impulse Spgs. (2 Reqd.)	4-36x $\frac{3}{8}$ " RHIMS
5	Impulse Spring	D-107254	29	Two-Hole Washer (2 Required)	D-17217
6	Two-Hole Washer	D-17216-B	30	Screw for Shunt Spgs. (2 Reqd.)	4-36x $\frac{7}{16}$ " RHIMS
7	Terminal Assembly	D-15462-A	31	Spring-Assem. Mtg. Scr. (2 Reqd.)	D-76310
8	Terminal Link	D-6138	32	Spring-Assembly Bracket	D-730176-A
9	Shunt Spring	D-107116-C	33	Mounting Base Assembly	D-78543-A
10	Insulator (3 Required)	D-17216-C	34	Finger Stop	D-3380-A
11	Terminal Assembly (2 Required)	D-15453-A	35	Finger-Stop Mtg. Scr. (2 Reqd.)	D-76309
12	Shunt Spring	D-103241	36	Number Card Clamping Plate	D-78541
13	Shunt Spring	D-109115-A	37	Number Card	AK-35
14	Bushing (2 Required)	D-75086	38	(For others, see p. 34)	
15	Nut for Impulse Cam	D-7714	39	Escutcheon Ring—Chrom.-Plated Black-Japanned	AK-39
16	Cupped Spring Washer for Cam	D-17185	40	Finger-Plate Mounting Screw	D-65112-D
17	Impulse Cam	D-83004	41	Escutcheon Lock	D-65112-A
18	Hub for Impulse Cam	D-82102	42	Bearing Screw for Governor	D-76312
19	Worm Gear Assembly	D-4377-A	43	Nut for Governor Mtg. (2 Reqd.)	D-5886
20	Bearing Washer for Worm Gear	D-17138	44	Governor Worm Assembly	D-76313
21	Number Plate (For others, see p. 34)	AK-30	45	Governor Cup Assembly	D-77041
22	Main Spring Assembly	D-109112-A	46	Finger-Plate—Chromium-Plated Black-Japanned	D-64030-A
23	Lower Thrust Washer	D-17219-A			D-2791-A
24	Ratchet Gear	D-4373			AK-58
				(For others, see p. 34)	AK-33

For the Type 24A36 Dial, see p. 33.



## Parts for Standard Monophone Handsets

Do not order by reference numbers—see tables below.

### Type 41 Handsets

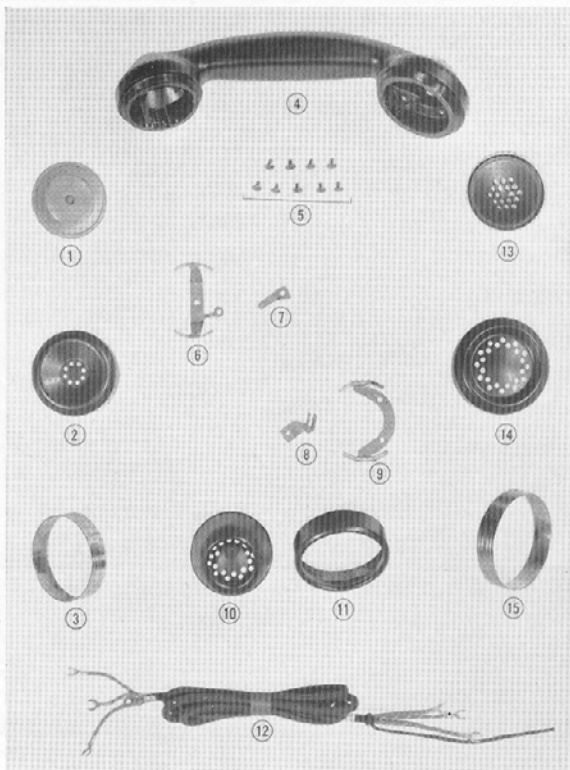

Ref. No.	Description	Order by No.
1	Type 41 Receiver Capsule	AF-54
2	Ear Cap—Black (or other on order)	D-67303-A
3	Band for Ear Cap—Chrom.-Plated	D-65342-A
4	Handset Shell—Black	D-52088-A
5	Screw (9 Required)	D-76351-A
6	Receiver Clip Spring	D-109481
7	Receiver Contact Spring	D-109482
8	Transmitter Contact Spring	D-109483
9	Transmitter Clip Spring	D-109484
10	Cupped Mouthpiece	D-38297-A
11	Ring (Cupped Mouthpiece only)	D-65340-A
12	Handset Cord	AH-27
13	Transmitter—Regular	AF-53
	Super-Volume	D-38290-A
14	Regular Mouthpiece	D-38307-A
15	Band for Mouthpiece	D-65341-A

### Type 38 Handsets

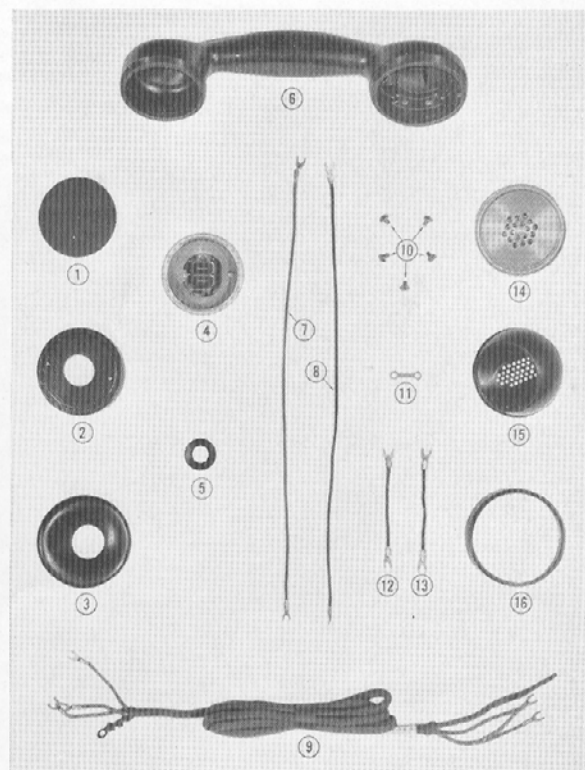

Ref. No.	Description	Order by No.
1	Diaphragm	D-38194
2	Receiver Retaining Ring	D-65129-C
3	Ear Cap—Black	D-67149-A
4	Receiver	AF-17
5	Ear Cap Bushing	D-75537-A
6	Handset Shell—Black	D-52048-A
7	Receiver Wire (Black)	D-541928-A
8	Receiver Wire (Blk.-Red)	D-541929-A
9	Handset Cord—Brown Braid	AH-11
10	Screw (5 Required)	D-76351
11	Terminal Link	D-6141
12	Transmitter Wire (Blk.-Red)	D-541930-A
13	Transmitter Wire (Black)	D-541931-A
14	Transmitter—Regular	AF-16
15	Mouthpiece—Regular	D-38210-A
16	Transmitter Retaining Ring	D-65124-C

For Complete Monophone Handsets, see p. 36.

## Parts for Ringers

Do not order by reference numbers—see tables below.

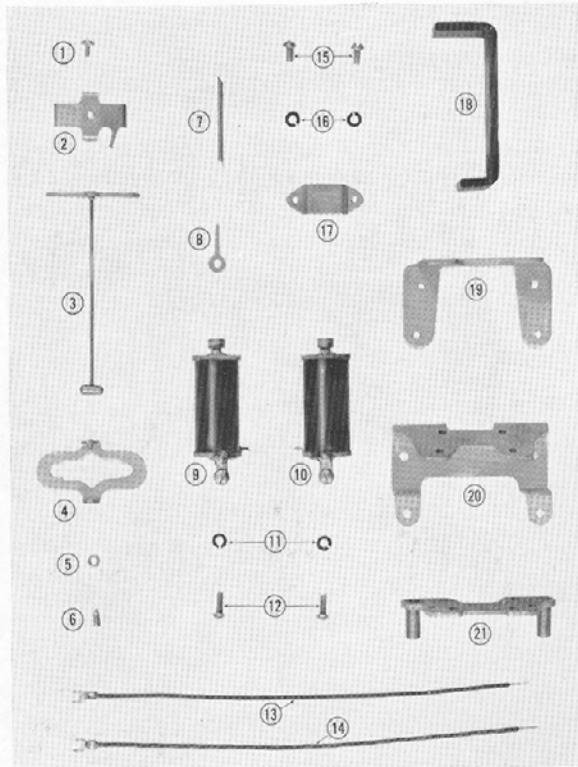

### Central-Battery Straight-Line Ringers

Ref. No.	Description	Order by No.
1	Hex. Head Screw for Armature	D-76218
2	Armature Adjusting Plate	D-78395
3	Armature and Clapper	D-56108
4	Armature Bracket	D-730331-A
5	Hex. Locknut for Bearing Screw	D-77119
6	Armature Bearing Screw	D-76409
7	Biasing Spring	D-109026
8	Biasing Spring Bracket	D-73261
9	Coil (Left)—For Types 40 and 50 (For 34A3B Mono., Rgr. Boxes, and Types 21A and 42 Wall Tels.)	D-281350-B
		D-281350-A
10	Coil (Right) For Types 40 and 50 (For 34A3B Mono., Rgr. Boxes, and Types 21A and 42 Wall Tels.)	D-281365-B
11	Lock Washer (2 Required)	D-281365-A
12	Coil Mounting Screw (2 Required)	D-17195-B
		8-32x $\frac{1}{16}$ " RHIMS
13	Wire (Blk.-Gr.) (For 34A3B, Rgr. Boxes, 21A and 42 Wall Tels.)	D-542445-A
14	Wire (Blk.-Wh.) (For 34A3B, Rgr. Boxes, 21A and 42 Wall Tels.)	D-542487-A
15	Screw for Magnet Clamp (2 Req'd.)	8-32x $\frac{5}{16}$ " RHIMS
16	Spring Washer (2 Required)	D-17195-B
17	Magnet Clamp	D-7366
18	Permanent Magnet	D-5648
19	Mounting Brkt. (For Types 40, 50)	D-730988
20	Mounting Bracket (For Type 34A3B)	D-730815
21	Mounting Brkt. (For Rgr. Boxes, and Types 21A and 42 Wall Tels.)	D-63075-A

NOTE—Gongs, and mounting parts for gongs, are shown with ringer boxes and telephones.

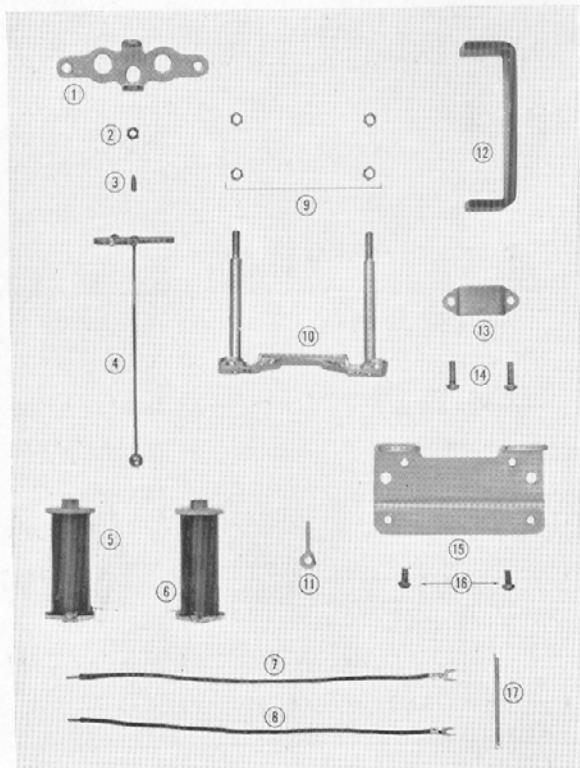

### Local-Battery Ringers

Ref. No.	Description	Order by No.
1	Yoke	MP-4209
2	Hex. Nut for Pivot Screw	D-77124-B
3	Pivot Screw	AP-1132
4	Armature and Clapper	MP-4800
5	Coil—Left—500 ohms	MP-4200
	800 ohms	MP-4202
	1250 ohms	MP-4204
6	Coil—Right—500 ohms	MP-4201
	800 ohms	MP-4203
	1250 ohms	MP-4205
7	Coil Wire (Blk.-Wh.)	D-542113-A
8	Coil Wire (Blk.-Bl.)	D-542114-A
9	Hex. Nut (4 Required)	AP-1131
10	Heelpiece	MP-5771
11	Biasing Spring Bracket	MP-5628
12	Permanent Magnet	MP-5452
13	Clamp for Magnet	MP-5461
14	Coil Mounting Screw (2 Required)	8-32x $\frac{1}{8}$ " RHIMS
15	Gong Bracket	MP-5316
16	Bracket Mounting Screw (2 Req'd.)	8-32x $\frac{5}{16}$ " RHIMS
17	Biasing Spring (If Required)	D-109026

For Complete Ringers, see p. 38

## Parts for Central-Battery Ringers—Harmonic

Do not order by reference numbers—see table below.

Ref. No.	Description	Order by No.
1	Armature Locking Nut	D-7747-A
2	Armature	D-7181
3	Thumb Nut	D-7733
4	Reed Locking Nut	D-7734
5	Clapper Rod	(See below)
6	Clapper	(See below)
7	Set Screw for Mounting Clapper	D-7684
8	Washer	D-1772
9	Reed	(See below)
10	Washer	D-1773
11	Reed Mounting Screw (2 Required)	6-32x $\frac{3}{16}$ " RHIMS
12	Armature Mounting Bracket	D-7461
13	Coil—Left	(See below)
14	Coil—Right	(See below)
15	Spring Washer (2 Req'd.)	D-17195-B
16	Coil Mounting Screw (2 Required)	8-32x $\frac{7}{16}$ " RHIMS
17	Wire (Blk.-Gr.) (For 34A3B, Rgr. Boxes, 21A and 42 Wall Sets)	D-542445-A
18	Wire (Blk.-Wh.) (For 34A3B, Rgr. Boxes, 21A and 42 Wall Sets)	D-542487-A
19	Clamp for Magnet	D-7366
20	Spring Washer (2 Required)	D-17195-B
21	Screw for Magnet Clamp (2 Req'd.)	8-32x $\frac{5}{16}$ " RHIMS
22	Permanent Magnet	D-5648
23	Mounting Bracket (For Types 40, 50)	D-730988
24	Mounting Bracket (For Type 34A3B)	D-730815
25	Mounting Bracket (For Rgr. Boxes, and Types 21A and 42 Wall Tels.)	D-63075-A

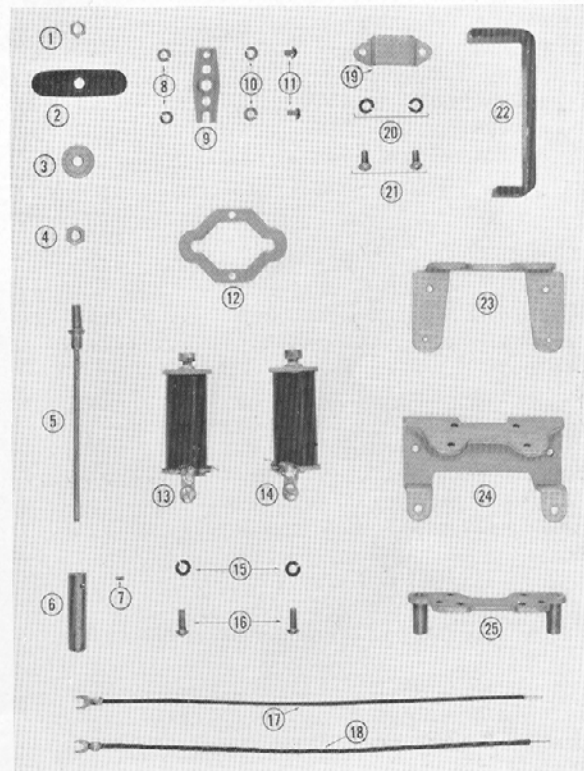

### The Following Parts Vary at Different Frequencies, as Shown:

Frequency, cycles	16.6	25	33.3	50	66	20	30	42	54
(5) Clapper Rod	D-5666	D-5667	D-5667	D-5667	D-5667	D-5666	D-5667	D-5667	D-5667
(6) Clapper	D-5660	D-56127	D-5661	D-5663	D-56025	D-56117	D-56009	D-56088	D-5663
(9) Reed	D-10927	D-10740	D-10740	D-10693	D-10699	D-10740	D-10740	D-10740	D-10693
(13) Coil—Left For Types 40 and 50 and 42 Wall Sets For 34A3, Rgr. Boxes, 21A Wall Sets	D-281346B D-281346A	D-281356B D-281356A	D-281348B D-281348A	D-281389B D-281389A	D-281389B D-281389A	D-281344B D-281344A	D-281353B D-281353A	D-281348B D-281348A	D-281389B D-281389A
(14) Coil—Right For Types 40 and 50 and 42 Wall Sets For 34A3, Rgr. Boxes, 21A Wall Sets	D-281347B D-281347A	D-281355B D-281355A	D-281349B D-281349A	D-281390B D-281390A	D-281390B D-281390A	D-281345B D-281345A	D-281354B D-281354A	D-281349B D-281349A	D-281390B D-281390A

For Complete Ringers, see p. 38.

## Complete Index

	<i>Page</i>		<i>Page</i>
<b>A</b>			
Accessories—Telephone .....	41-42	Outdoor Types .....	21,23
Adapter for Capsule Transmitter .....	50	Type 21A Desk .....	19
Anti-Noise Monophone Handset .....	36	Type 21A Wall .....	20
Art Shade Monophones .....	7-17	Type 42 Wall .....	18
Autodial .....	41	Wall .....	10-11,17,18,20-23
Automatic Telephones .....	7-23	Chimes—Telephone .....	30
Flush Type .....	22	Coils—Induction .....	45,46,48,49,51-53
Mine Type .....	23	Coin Collectors .....	40
Monophones .....	8-17,21	Colored Monophones .....	7-17
Desk .....	8-9,12-17	Compact Type Ringer Boxes .....	29
Extension .....	17	Condenser Brackets .....	48,51,53
Wall .....	10-11,21	Condensers .....	45,46,48,49,51-53
Weatherproof .....	21,23	Connecting Blocks—Line and Cord .....	41
<b>B</b>			
Base for W. E. Co. Desk Stands .....	35	Continuous Signaling Unit .....	32
Battery Boxes .....	42	Conversion Kits—Monophone .....	43
Bell Boxes .....	29-30	Convertible Manual Telephones—C.B. ....	8-23
Bells—Loud-Ringing .....	32	Cords—Hand Test Telephone .....	43
Bells—Waterproof .....	32	Cords—Operators' Set .....	42
Biasing Springs—Ringer .....	56	Cords—Telephone .....	39,40,45-52,55
Blanks—Dial .....	35	Extensicord .....	40
Blocks—Connecting .....	41	Cover—Celluloid, for Number Cards .....	34,35
Boxes—Extension—C.B. ....	31	Cover Plates—Dial Hole .....	35
Boxes—Extension Ringer—Mag. ....	31	Cradle—Handset .....	47
Boxes—Ringer—C.B. ....	15,29-30	Cups—Dial Mounting .....	35
Compact Type .....	29	“Cutaway” Dial Finger Plate .....	34
For Two-Line Monophones .....	15	<b>D</b>	
Metal .....	15,29	Desk Lamp Signals .....	31
Monochime .....	30	Desk Telephones—C.B. ....	8-9,12-17,19,23
Ringer—Magneto .....	30	Extension .....	17
Bracket for Extension Monophone .....	17,26	Key-Type .....	14-15
Bracket Monophone .....	23	Desk Telephones—Magneto .....	24,27
Brackets—Condenser .....	48,51,53	“Forestry” .....	24
Brackets—Ringer Mounting .....	56,57	Desk Stand Cords .....	39
Breastplate Sets .....	42	Dial Hole Cover Plates .....	35
“Buttinsky” (Hand Test Telephone) .....	43	Dial Mounting Cups .....	35
<b>C</b>			
Cam- and Impulse-Spring Adjusting Pliers .....	44	Dial Parts .....	34
Cam-Nut and Governor Wrench—Dial .....	44	Dial Tools .....	44
Cam-Nut Socket Wrench—Dial .....	44	Dial Wires .....	47,50,51
Cards—Dial .....	34	Dials .....	33
Carrying Handle for Type 40 Monophone .....	45	Diaphragms—Handset Receiver .....	55
Central-Battery Extension Boxes .....	31	<b>E</b>	
Central-Battery Ringer Boxes .....	15,29,30	Ear Cap, Receiver .....	50
Compact Type .....	29	Handset .....	55
For “Two-Line” Monophones .....	15	Elevator-Cab Telephone .....	22
Metal .....	29	Escutcheon-Lock Tool—Dial .....	44
Monochime .....	30	Extension Bells .....	32
Central-Battery Telephones .....	7-23	Extension Boxes—C.B. ....	31
Bracket .....	23	Extension Monophones—C.B. ....	17
Desk .....	8-9,12-17,19,23	Extension Monophones—Magneto .....	26
Extension .....	17	Extension Ringer Boxes—Magneto .....	31
Flush-Wall Type .....	22	<b>F</b>	
Handset Type .....	7-21,23	Finger Plates—Dial .....	34,54
Mine-Type .....	23	Flush Wall Telephones .....	22
		Forestry Service Telephones .....	24,26,28

<b>G</b>	<i>Page</i>	<b>H</b>	<i>Page</i>
Generator Crank .....	52	Handset Cords .....	39,40
Generators .....	52	Handset Parts .....	55
Governor and Cam Nut Wrench.....	44	Handsets—Monophone .....	36
Gongs—Ringer .....	45,46,48,49,51,53	Handset Telephones—C.B. ....	7-17,23,21
		Desk .....	8-9,12-17,23
		Extension .....	17
		Key-Type .....	14,15
		Outdoor .....	21
		Handset Telephones—Magneto ..	24-26,28
		Desk .....	24
		Extension .....	26
		“Forestry” .....	24,26
		Outdoor .....	28
		Wall .....	25,26,28
		Hand Test Telephones.....	43
		Harmonic Ringer Movements.....	38
		Headsets—Operators’ .....	42
		Hookswitches .....	49-52
		<b>I</b>	
Induction Coils .....	45,46,48,49,51-53		
Information—Ordering .....	4		
Impulse- and Cam-Spring Adjusting Pliers.....	44		
		<b>J</b>	
		Jacks and Plugs—Portable Telephone.....	42
		<b>K</b>	
Keys—Telephone Switching .....	41		
Key-Type Monophones .....	14-15		
Kits—Monophone Conversion .....	43		
		<b>L</b>	
Lamp Signals and Relays.....	31		
Lift Handle for Type 40 Monophone.....	45		
Line-and-Cord Terminal Blocks.....	41		
Local-Battery Telephones .....	24-28		
Desk .....	24		
Extension .....	26		
“Forestry” .....	24,26,28		
Outdoor .....	28		
Wall .....	25,26		
Loud-Ringing Bells .....	32		
		<b>M</b>	
Magneto Generators .....	52		
Magneto Telephones .....	24-28		
Desk .....	24		
Extension .....	26		
		“Forestry” .....	24,26,28
		Outdoor .....	28
		Wall .....	25,26,28
		Mine-Type Telephone—C.B. ....	23
		Mine-Type Telephone—Magneto ..	28
		Monochime .....	30
		Monophone Conversion Kits .....	42
		Monophone Handsets .....	38
		Monophones—C.B. ....	7-17,21,23
		Bracket .....	23
		Desk .....	8-9,12-17,23
		Extension .....	17
		Key-Type .....	14-15
		Outdoor .....	21
		Monophones—Magneto .....	24-26,28
		Desk .....	24
		Extension .....	26
		“Forestry” .....	24,26
		Outdoor .....	28
		Wall .....	25,26,28
		Monophone Switches .....	45-48
		Monophone Tools .....	44
		Monotype Cords—Telephone .....	39
		Mounting Cups—Dial .....	35
		Mouthpieces—Transmitter .....	37,50,52,55
		<b>N</b>	
		“Nickel Grabber” (Coin Collector).....	40
		Number-Card Holders .....	35
		Number Plates—Dial .....	34
		<b>O</b>	
		Offset Base for W.E. Desk Stand.....	35
		Operators’ Sets .....	42
		Ordering Information .....	4
		Outdoor Signals .....	32
		Outdoor Telephones—C.B. ....	21,23
		Outdoor Telephones—Magneto .....	28
		<b>P</b>	
		Parts—Telephone .....	33-39,45-52
		Paystation Coin Collectors .....	40
		Plates—Dial Hole Cover.....	35
		Plates—Dial Number .....	27
		Pliers—Impulse- and Cam-Spring Adjusting.....	29
		Portable Telephone Plugs and Jacks.....	42
		<b>R</b>	
		“Radio Suppressors” .....	33,35
		Receiver Cords .....	39

	<i>Page</i>
Receiver Hooks .....	49-52
Receiver Parts .....	50
Receivers .....	37
Relay Boxes .....	31
Ringer Boxes .....	15,29-30
Compact Type .....	29
For Two-Line Monophones.....	15
Metal .....	15,29
Monochime .....	30
Ringer Parts .....	56-57
Ringers .....	38

**S**

Self-Contained Desk Monophone—C.B.....	8-9
Self-Contained Desk Monophone—Magneto.....	24
“Subsets” (Ringer Boxes).....	29-30
“Suppressors”—Radio .....	33,35
Signals—Telephone .....	29-32
Continuous Signaling .....	32
Desk Lamp .....	31
Loud-Ringing Bell .....	32
Monochime .....	30
Ringer Boxes .....	29-30
Socket Wrench—Dial Cam Nut.....	44
Special Telephones .....	21-23,28
Bracket Monophone .....	17
Flush-Wall Telephones .....	22
“Key-Type” Monophones .....	14-15
Mine Telephone—C.B. ....	23
Mine Telephone—Magneto .....	28
Outdoor Monophones—C.B. ....	21
Outdoor Monophones—Magneto .....	28
Test Telephone (“Buttinsky”).....	43
Splashproof Dial .....	33
Spring Assemblies—Dial .....	34
Switching Keys .....	41
Switching Key Monophones.....	14-15
Suspended-Transmitter Sets .....	42
Switches—Monophone .....	45-48

**T**

Telephone Chimes .....	30
Telephone Switching Keys.....	41
Telephones—C.B. ....	7-23
Desk .....	8-9,12-17,19,23
Extension .....	17
Bracket .....	23
Flush-Wall Type .....	22
Handset Type .....	7-21,23
Mine Type .....	23
Outdoor Types .....	21,23
Wall .....	10-11,17,18,20-23
Telephones—Mag. ....	24-28
Desk .....	24

Extension .....	26
“Forestry” .....	24,26,28
Outdoor .....	28
Wall .....	25-26
Terminal Blocks—Line and Cord.....	41
Terminal Strips .....	46,49,51,53
Test Telephones .....	43
Tools—Dial and Monophone.....	44
Transmitter Cords .....	49,51,52,55
Transmitter Mouthpieces .....	37,50,55
Transmitters .....	37,55
“Two-Line” Monophones .....	14-15

**Type Number Index**

Type 1A Desk Monophone—C.B.....	12-13
Magneto .....	24
Type 4A Extension Monophone—C.B.....	17
Type 6 Transmitter .....	37
Type 8 Desk Monophone—Mag. ....	24
Type 10 Coin Collector .....	40
Type 10 Wall Monophone—Mag. ....	25
Type 17 Extension Monophone—Mag. ....	26
Type 18 Wall Monophone—Mag. ....	25
Type 21A Desk Telephone—C.B.....	19
Magneto .....	27
Type 21A Wall Telephone—C.B.....	20
Type 24A36 Dial .....	33
Type 29 Coin Collector .....	40
Type 32 Extension Boxes—C.B. ....	31
Type 32 Ringer Boxes—C.B. ....	29
Type 23 Receiver .....	37
Type 38 Monophone Handset .....	36
Type 40 Desk Monophone—C.B. ....	8-9
Magneto .....	24
Type 41 Monophone Handset .....	36
Type 41 Monophone Receiver .....	55
Type 41 Monophone Transmitter .....	55
Type 42 Receiver .....	37
Type 42 Transmitter .....	37
Type 42 Wall Telephone—C.B. ....	18
Type 50 Wall Monophone—C.B. ....	10-11
Type 200 Wall Set—Mag. ....	52
Type 371B Wall Monophone—Mag.....	26

**W**

Wall Telephones.....	10-11,18,20-23,25,28
Central-Battery .....	10-11,18,20-23
Flush Wall .....	22
Magneto .....	23,25,28
Outdoor—C.B. ....	21,23
Outdoor—Magneto .....	28
Mine-Type—C.B. ....	21
Mine-Type—Magneto .....	28
Waterproof Bells .....	32
Wrenches—Dial and Monophone.....	44

**For Ordering Information, see page 4**

(Supersedes Catalog 4055B and all Preceding Telephone Catalogs)

Printed in the United States of America—6-40—Merit—7500